

BETA LAB NO.M10198, REV. 1 - Tesoro E6600 HEAT EXCHANGER "E". SUMMARY OF THE RESULTS  PART: 6600-E HEAT EXCHANGER "E", ALL PARTS DAMAGE DEPTH, AND PART 17 MOUNTS	TESORO REFINING AND MARKETING COMPANY ANACORTES REFINERY 10200 W. MARCH POINT ROAD T91WA4428 ANACORTES, WA 98221	CUSTOMER P.O. No.: 4501667904
		DATE: 3/7/2011
		PAGE 1 OF 70

**LABORATORY REPORT**

CONTACT:	JIM McVAY
ISSUED BY:	MARK BRIDAVSKY
TELEPHONE EXTENSION:	440-604-9862
MAIL STOP:	A- BETA
REVIEWED BY :	JEFF BLOUGH

**REPORT ISSUED TO:**

Jim McVay	Robert J. Hall	Robert Parker
-----------	----------------	---------------

**This is a Revision 1 of the report due to the following changes:**

- **Table 2, Average hardness for the OD line changed to 87 (was 81 due to a typing error)**
- **Figure 27– micrographs of the right of the weld area are added.**
- **Figure 27 and Table 11 - The depth of the damage left of the weld changed to 19.9 (was 0.217). It is important to notice that from approximately 0.2 mm from the ID and to the deepest damage at 19.9 mm from ID no other damage was observed.**

**SAMPLE DESCRIPTION:** The heat exchanger, labeled E6600 "E" (Echo), failed and a test protocol was developed for the failure analysis of the component. This test protocol and its addendum, as of this date and contained in Attachment 1, were developed and signed by Tesoro Companies, Division of Occupational Safety and Health and U.S. Chemical Safety Board. FirstEnergy BETA Laboratory was selected as the referee test laboratory to perform the testing requirements of the test protocol. The test protocol was not specific as to the test samples to be removed from the heat exchanger or the test locations/test parameters for each specific test within the test sample. Therefore it was agreed

"The laboratory, acting as a referee laboratory, will be supplied the locations to take the test samples and the type of test and test parameters to be performed at each location on the test sample, i.e. magnification, hardness load/test method. The signatory parties or their technical representatives that are present in the laboratory at the time shall make those decisions and give that information directly to the laboratory. Comments from other technical experts will be considered and factored into the signatory parties or their technical representative's decisions but all decisions on protocol or samples shall remain as decisions of the signatory parties or their representatives."

Additionally it was determined that BETA laboratory as a referee test laboratory is to report the data obtained, but not give any interpretation or conclusion on any data, or on details in the photos.

This interpretive report is a result of testing/analysis derived from material, information and/or specifications furnished by the customer and is confidential and is intended for the customer only. If you are receiving it in error, please advise immediately. Further, you are prohibited from disclosing, copying, distributing or using any of this information without written approval from Beta Lab. This report shall not be reproduced except in its entirety and, in any case, without prior written approval from Beta Lab. Except for such obligations as are set forth in the Agreement between Beta Lab and its customer for whom this work has been performed, neither the party preparing this report nor any person acting on its behalf: Makes any warranty or representation, express or implied, including merchantability or fitness for a particular purpose, with respect to the accuracy, completeness or usefulness of the information contained in this report, or that the use of any information, apparatus method or process disclosed from this report does not infringe upon privately owned rights or intellectual property; or Assumes any liability with respect to the use of, or for damages, including consequential or punitive damages, resulting from the use of, any information, apparatus, method or process disclosed in this report.

BETA LAB NO. M10198, REV. 1 - Tesoro E6600 HEAT EXCHANGER "E". SUMMARY OF THE RESULTS  PART: 6600-E HEAT EXCHANGER "E", ALL PARTS DAMAGE DEPTH, AND PART 17 MOUNTS	TESORO REFINING AND MARKETING COMPANY ANACORTES REFINERY 10200 W. MARCH POINT ROAD T91WA4428 ANACORTES, WA 98221	CUSTOMER P.O. No.: 4501667904
		DATE: 3/7/2011
		PAGE 2 OF 70

### LABORATORY REPORT

On June 5, 2010 the heat exchanger arrived at Halvorsen Company's warehouse, in a June 11, 2010 meeting locations were selected for sample removal and on June 12, 2010 samples were cut by Halvorsen for submittal to BETA laboratory. The results of the receipt inspection for the heat exchanger at Halvorsen Companies warehouse are contained in FirstEnergy's report titled M10198- Receipt dated July 30, 2010.

This report contains the summary of the results obtained in ten previous reports, measurements of the damage penetration on all mounts, as well as evaluation of the Part 17, mounts from weld LS1 labeled LS-1 and 17-LS1 (see layout of the mounts on Figure 1).

This report is the eleventh in a series of the reports on the failed parts ("E") of the 6600E heat exchanger "E". The LS# and CS# refer to longitudinal and circumferential weld seams respectively, while the part number refers to the chain of custody number.

Below is the list of the previously issued reports with information on the location of the mounts in the reports:

#	REPORT	DATE	MOUNTS EXAMINED IN THE REPORT
1	M10198 Tesoro Receipt Inspection	7/30/10	NA
2	M10198 Tesoro LS3 Bottom Findings	7/30/10	14-m1, 14-m2, 14-m3, 14-m4, 14-m4T, 14-m5, 14-m6, 14-T0
3	M10198 Tesoro CS4 Findings	8/5/10	19W-m1, 19W-m2, 19W-m3, 19E-m4-
4	M10198 Tesoro LS2-CS3 Tee Indications Findings	8/13/10	T2, T2C, T2L
5	M10198 Tesoro CS4-01/LS3 Bottom Findings	8/25/10	See Report 7
6	M10198 Tesoro LS1-CS2 LS2-CS3 CS4 Mechanical Tests	8/27/10	NA
7	M10198 Tesoro CS4-01/LS3 Bottom Findings, Rev. 1	9/20/10	18-m1, 18-m2, 18-m3, 19E-18-m3
8	M10198 Tesoro LS03 Top Findings	9/20/10	15-m3, 15-m4T, 15-T0
9	M10198 Tesoro LS03 Bottom – Fractography and 19-m5 Mount	9/23/10	19E-m5
10	M10198 Tesoro LS2 and LS2-CS2 Tee Findings	10/13/10	LS-22", LS2-36", CS2-A, LS2-A
11	M10198 Tesoro 6600E Heat Exchanger „E“. Summary of the Results and Part 17 Mounts Evaluation	2/2/11	New LS1, 17-LS1 and all mounts in the above 10 reports

BETA LAB NO.M10198, REV. 1 - Tesoro E6600 HEAT EXCHANGER "E". SUMMARY OF THE RESULTS	TESORO REFINING AND MARKETING COMPANY ANACORTES REFINERY 10200 W. MARCH POINT ROAD T91WA4428 ANACORTES, WA 98221	CUSTOMER P.O. No.: 4501667904
PART: 6600-E HEAT EXCHANGER "E", ALL PARTS DAMAGE DEPTH, AND PART 17 MOUNTS		DATE: 3/7/2011
		PAGE 3 OF 70

## LABORATORY REPORT

**TESTS PERFORMED:** The tests of the Part 17 of the exchanger in this report included visual examination, photo-microscopy of two cross sections removed from the LS1 weld joints, hardness traverses of base and weld metals on 17-LS1 sample.

This report summarizes most of the data obtained in previous reports – chemical composition of the base and weld metal, Rockwell hardness of the base metal, semi-micro Vickers hardness of the welded connections (converted to Rockwell hardness, scale B (HRB) for ease of comparison), mechanical properties of the base metal and welded joints – tensile and impact.

Additionally it was requested to measure, on all mounts evaluated in all previous reports, the depths of the damage, the damage location (base metal (BM), weld metal (WM), fine grain heat affected zone (FG HAZ), or coarse grain of heat affected zone (CG HAZ), the width of the CG HAZ and FG HAZ at the locations of the deepest damage, as well as to take the microphotographs of the deepest damage. The damage evaluation was performed at the magnification of 50X with occasional examination at 200X if a clarification of the damage was needed.

The details of the apparatus utilized and the test procedures are given in Table 1 and Attachment 2.

**TEST RESULTS:** The heat exchanger weld seams had been previous labeled as shown in Figure 1 and the same labeling was used for this report.

The new test data in this report are from samples Part 17, weld LS1 close to LS1-CS2 Tee (sample labeled LS-1) and a sample labeled 17-LS1 5"-plus down the weld LS-1 from the sample LS1 (see Figure 1A and 2 for the samples location, and Figures 3 through 6 for the metallography). The results of the semi-micro hardness test are on Figure 7 and Table 2 (page 13). The sample locations as well as the scopes of the evaluation were chosen by others.

The summary of the test data obtained in all the previous reports contained:

- chemical composition of the base metal of cans 1 through 4, plus the chemistry of the clad material (Table 3),
- Rockwell hardness of the plates, cans 1 through 4 (Table 4),
- summary of the traverses semi-micro Vickers hardness (converted to Rockwell hardness in this report) of the base metal, HAZ and weld metal of the welded connections of the circumferential welds CS2, CS3, CS4, and longitudinal welds LS1, LS2, LS3, and LS4. (Table5);
- room temperature tensile properties of base metal (cans 1 through 4, Table 6),
- room temperature tensile properties of four welded joints (two longitudinal and two circumferential, Table 7),
- bend test of four welded joints (Table 8),
- impact testing of the base metal at five temperatures (Table 9 and Figure 8)
- impact testing of four weld metals at 0°F (Table 10).

The results of the depth of the damage measurements and the damage locations are in Table 11. The micro-photographs are in Figures 10 through 35. On the Figure 9 are the definitions of the damage locations as it was devised by others and used in this report.

BETA LAB NO.M10198, REV. 1 - Tesoro E6600 HEAT EXCHANGER "E". SUMMARY OF THE RESULTS  PART: 6600-E HEAT EXCHANGER "E", ALL PARTS DAMAGE DEPTH, AND PART 17 MOUNTS	TESORO REFINING AND MARKETING COMPANY ANACORTES REFINERY 10200 W. MARCH POINT ROAD T91WA4428 ANACORTES, WA 98221	CUSTOMER P.O. No.: 4501667904
		DATE: 3/7/2011
		PAGE 4 OF 70

**LABORATORY REPORT**

**TABLE 1**  
**TESTS PERFORMED and ADDRESSED IN THIS REPORT**  
 (See Attachment 2 for Test/Equipment Specifications)

TEST	METHOD OR INSTRUMENT	PERFORMED BY	LOCATION, DATE	RESULTS LOCATION
<b>VISUAL EXAMINATION</b>	<b>LECO SZH STEREO MICROSCOPE OR PORTRAIT CAMERA</b>	<b>J. BLOUGH AND M. BRIDAVSKY</b>	<b>BETA, VARIOUS</b>	<b>TEST RESULTS</b>
<b>ROCKWELL HARDNESS</b>	<b>NEWAGE NI300-C HARDNESS TESTER</b>	<b>M. TASCAR</b>	<b>BETA, VARIOUS</b>	<b>TABLE 4</b>
<b>SEMI-MACRO VICKERS</b>	<b>INSTRON TUKON 2100B HARDNESS TESTER, MODEL T2100BR1942</b>	<b>M. TASCAR</b>	<b>BETA, VARIOUS</b>	<b>TABLES 2 AND 5 FIGURE 7</b>
<b>OPTICAL METALLOGRAPHY</b>	<b>LECO PMG-3 OPTICAL MICROSCOPE</b>	<b>M. BRIDAVSKY</b>	<b>BETA, VARIOUS</b>	<b>FIGURES 3-6, 10 -35</b>
<b>LINEAR MEASUREMENTS</b>	<b>LECO PMG-3 OPTICAL MICROSCOPE WITH BUEHLER OMNIMET SYSTEM</b>	<b>M. BRIDAVSKY</b>	<b>BETA, VARIOUS</b>	<b>TABLE 11</b>
<b>MECHANICAL PROPERTIES</b>	<b>TENSILE, IMPACT AND BEND TESTS</b>	<b>TENSILE TESTING METALLURGICAL LABORATORY (TTML)</b>	<b>TTML, VARIOUS</b>	<b>TABLES 6-10, FIGURE 8</b>
<b>CHEMICAL ANALYSIS</b>	<b>THERMO ARL-3460 OE SPECTROMETER</b>	<b>M. TASCAR</b>	<b>BETA, VARIOUS</b>	<b>TABLE 3</b>
<b>CARBON ANALYSIS</b>	<b>LECO CARBON/SULFUR DETERMINATION CS-444</b>	<b>M. BELVISO</b>	<b>BETA, VARIOUS</b>	<b>TABLE 3</b>

BETA LAB NO.M10198, REV. 1 - Tesoro E6600  
HEAT EXCHANGER "E". SUMMARY OF THE RESULTS  
PART: 6600-E HEAT EXCHANGER "E", ALL PARTS  
DAMAGE DEPTH, AND PART 17 MOUNTS

TESORO REFINING AND MARKETING COMPANY  
ANACORTES REFINERY  
10200 W. MARCH POINT ROAD T91WA4428  
ANACORTES, WA 98221

CUSTOMER P.O. No.: 4501667904  
DATE: 3/7/2011  
PAGE 5 OF 70

**LABORATORY REPORT**

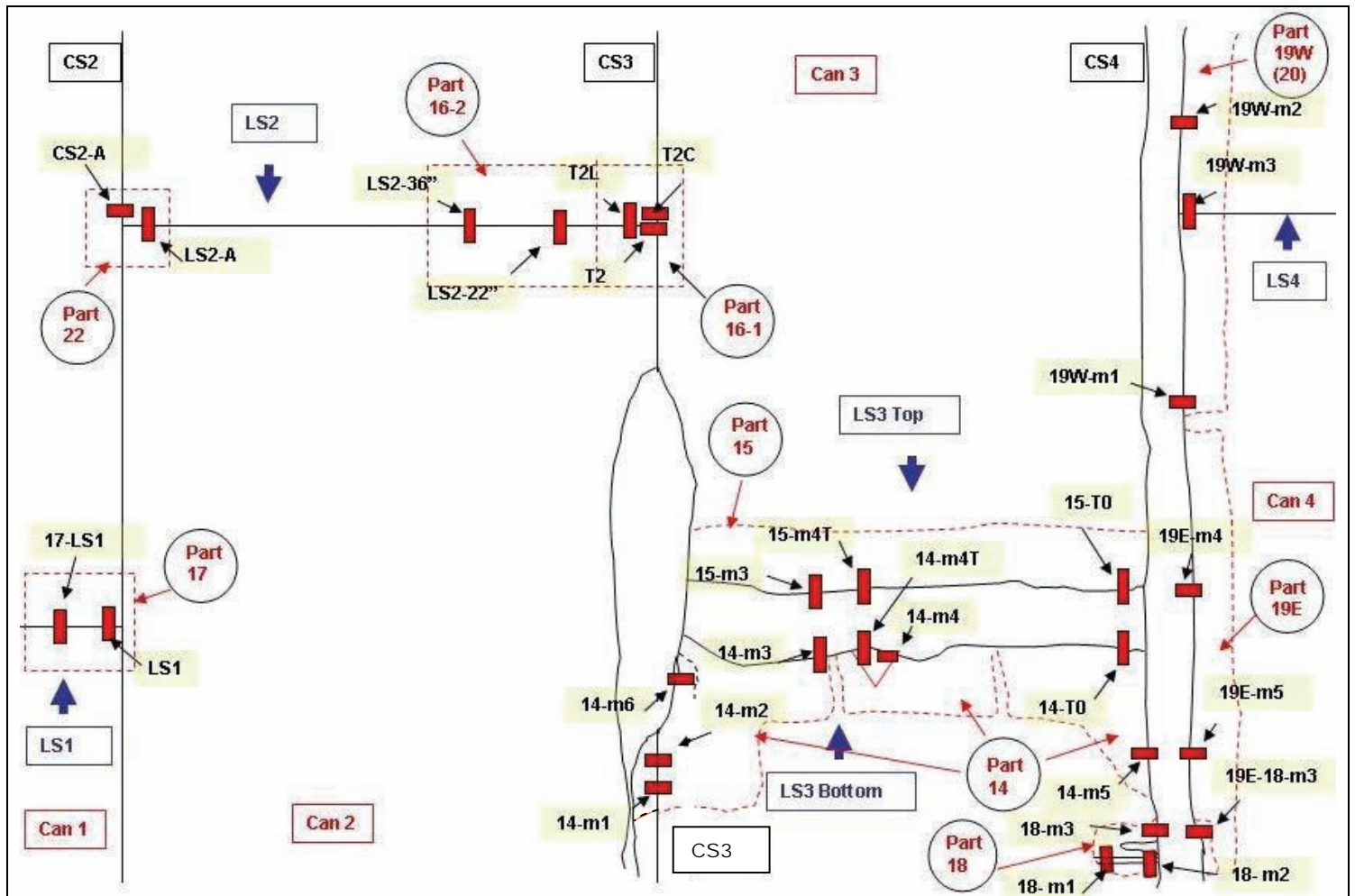

Figure 1A. Layout of all examined metallographic samples. The schematic representation of the failed exchanger is on Figure 1B next page. You are looking at O.D. Straight labeled lines are welds and irregular lines are fracture edges, Not to scale

BETA LAB NO.M10198, REV. 1 - Tesoro E6600 HEAT EXCHANGER "E". SUMMARY OF THE RESULTS	TESORO REFINING AND MARKETING COMPANY ANACORTES REFINERY 10200 W. MARCH POINT ROAD T91WA4428 ANACORTES, WA 98221	CUSTOMER P.O. No.: 4501667904
PART: 6600-E HEAT EXCHANGER "E", ALL PARTS DAMAGE DEPTH, AND PART 17 MOUNTS		DATE: 3/7/2011
PAGE 6 OF 70		

**LABORATORY REPORT**

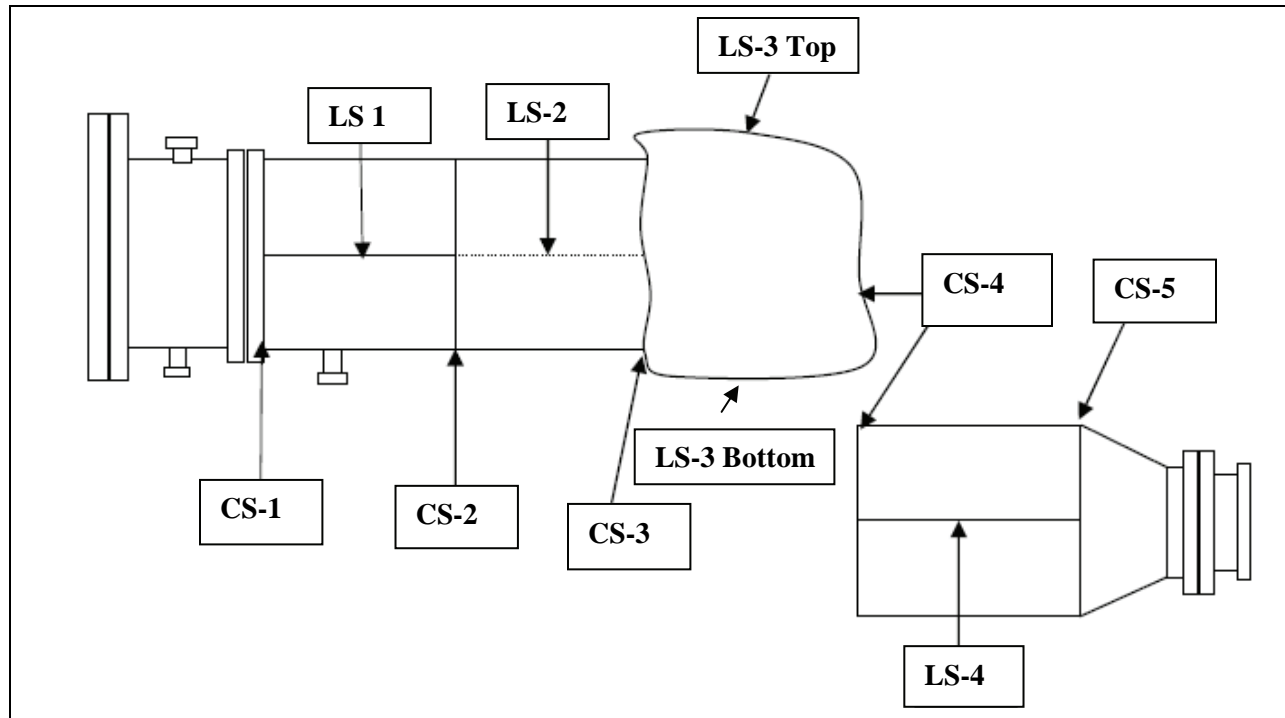

Figure 1B. Schematic representation of the failed exchanger. Layout of all examined metallographic samples is on Figure 1A on previous page. Not to scale

BETA LAB NO.M10198, REV. 1 - Tesoro E6600 HEAT EXCHANGER "E". SUMMARY OF THE RESULTS	TESORO REFINING AND MARKETING COMPANY ANACORTES REFINERY 10200 W. MARCH POINT ROAD T91WA4428 ANACORTES, WA 98221	CUSTOMER P.O. No.: 4501667904
PART: 6600-E HEAT EXCHANGER "E", ALL PARTS DAMAGE DEPTH, AND PART 17 MOUNTS		DATE: 3/7/2011
		PAGE 7 OF 70

**LABORATORY REPORT**

**PART 17**

**MOUNTS**

**LS-1**

**AND**

**17-LS-1**

BETA LAB NO.M10198, REV. 1 - Tesoro E6600  
HEAT EXCHANGER "E". SUMMARY OF THE RESULTS  
PART: 6600-E HEAT EXCHANGER "E", ALL PARTS  
DAMAGE DEPTH, AND PART 17 MOUNTS

TESORO REFINING AND MARKETING COMPANY  
ANACORTES REFINERY  
10200 W. MARCH POINT ROAD T91WA4428  
ANACORTES, WA 98221

CUSTOMER P.O. No.: 4501667904

DATE: 3/7/2011

PAGE 8 OF 70

**LABORATORY REPORT**

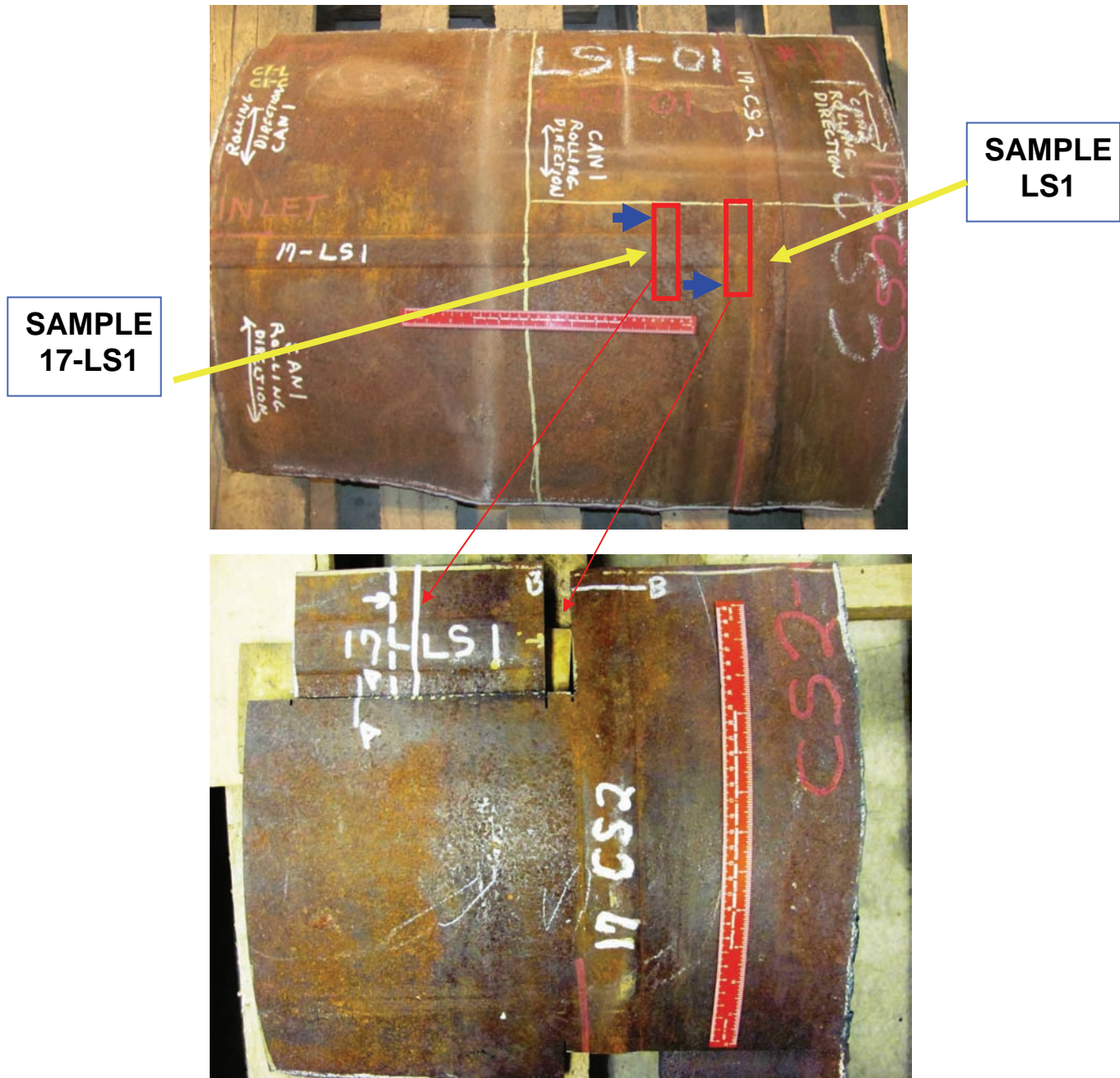
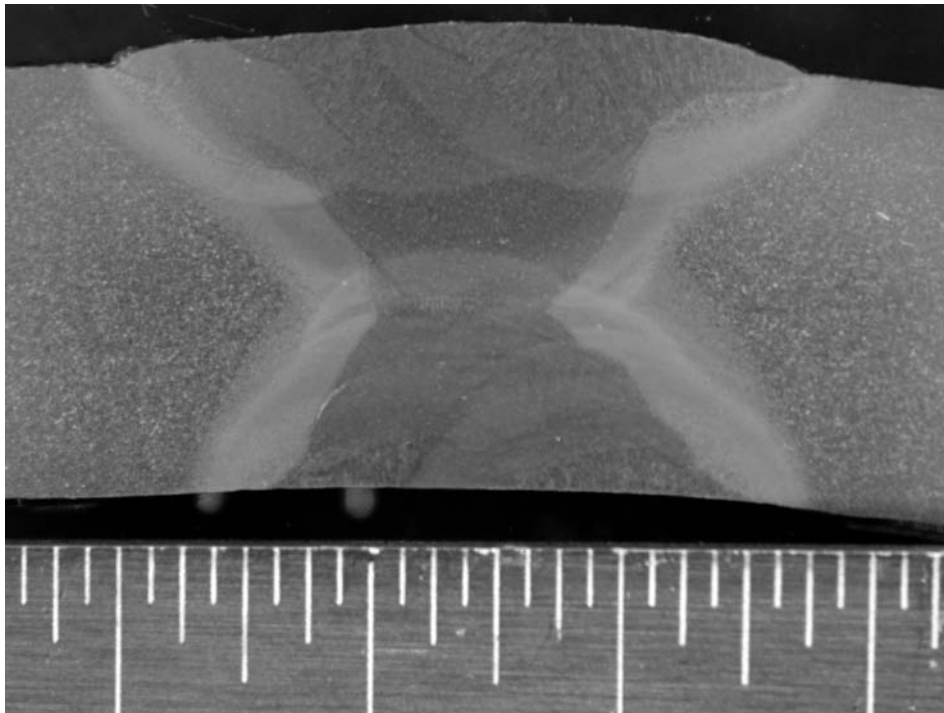

Figure 2. Blue arrows indicate the side to be polished.



BETA LAB NO.M10198, REV. 1 - Tesoro E6600 HEAT EXCHANGER "E". SUMMARY OF THE RESULTS	TESORO REFINING AND MARKETING COMPANY ANACORTES REFINERY 10200 W. MARCH POINT ROAD T91WA4428 ANACORTES, WA 98221	CUSTOMER P.O. No.: 4501667904
PART: 6600-E HEAT EXCHANGER "E", ALL PARTS DAMAGE DEPTH, AND PART 17 MOUNTS		DATE: 3/7/2011
PAGE 9 OF 70		

**LABORATORY REPORT**  
**SAMPLES LS1 AND 17-LS1**  
**MACROS**



**LS1**

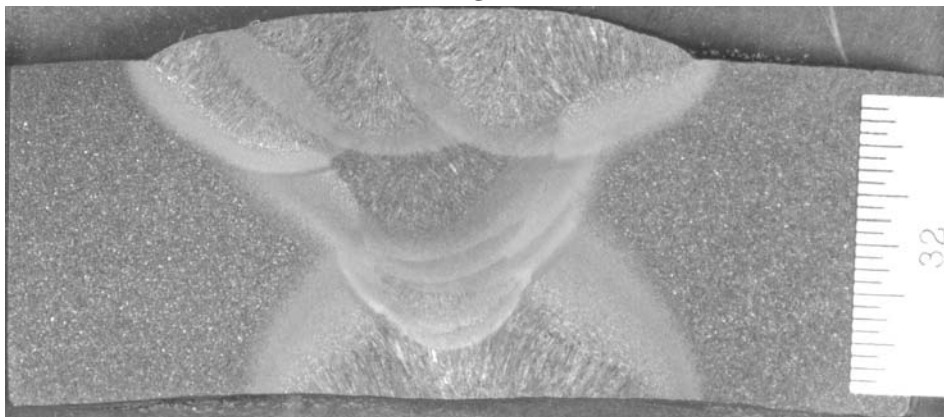

**17-LS1**

Figure 3, OD is on top and ID on bottom

BETA LAB NO. M10198, REV. 1 - Tesoro E6600  
HEAT EXCHANGER "E". SUMMARY OF THE RESULTS  
PART: 6600-E HEAT EXCHANGER "E", ALL PARTS  
DAMAGE DEPTH, AND PART 17 MOUNTS

TESORO REFINING AND MARKETING COMPANY  
ANACORTES REFINERY  
10200 W. MARCH POINT ROAD T91WA4428  
ANACORTES, WA 98221

CUSTOMER P.O. No.: 4501667904

DATE: 3/7/2011

PAGE 10 OF 70

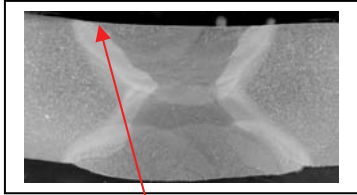

**LABORATORY REPORT  
SAMPLE LS1  
METALLOGRAPHY**

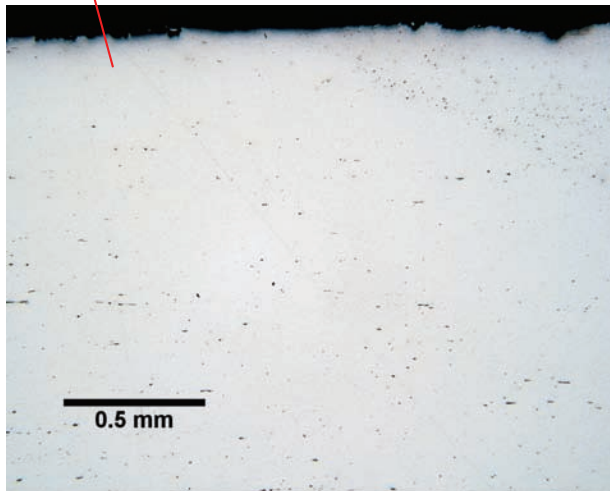

Microstructure at the toe at the left of the weld. Un-etched

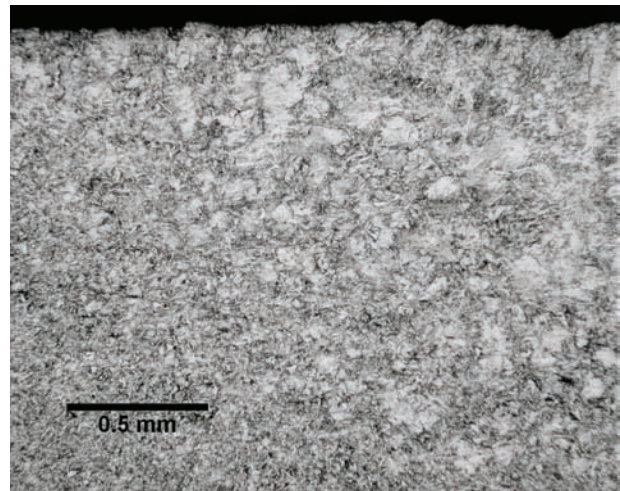

Same as at left. Etched

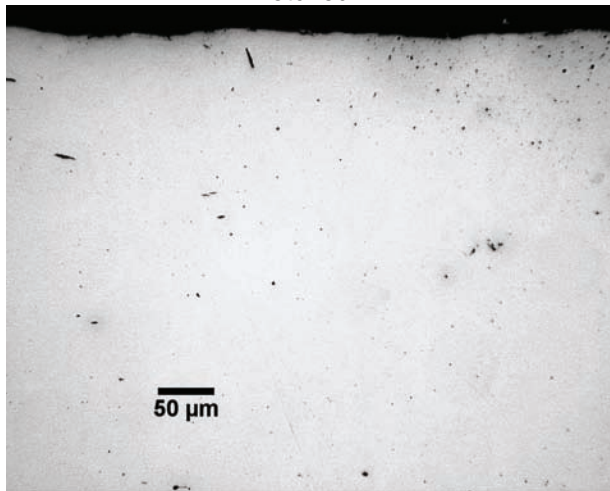

Same as above at higher magnification. Un-etched

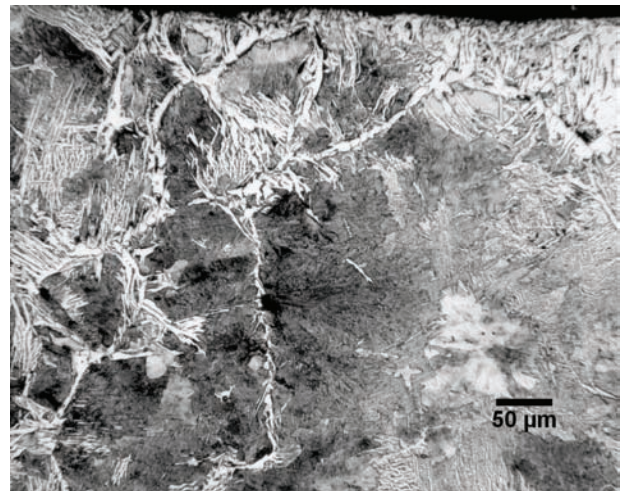

Same as at left. Etched

Figure 4. ID is on the top.

BETA LAB NO.M10198, REV. 1 - Tesoro E6600 HEAT EXCHANGER "E". SUMMARY OF THE RESULTS	TESORO REFINING AND MARKETING COMPANY ANACORTES REFINERY 10200 W. MARCH POINT ROAD T91WA4428 ANACORTES, WA 98221	CUSTOMER P.O. No.: 4501667904
PART: 6600-E HEAT EXCHANGER "E", ALL PARTS DAMAGE DEPTH, AND PART 17 MOUNTS		DATE: 3/7/2011
		PAGE 11 OF 70

**LABORATORY REPORT**  
**SAMPLE LS1**  
**METALLOGRAPHY**

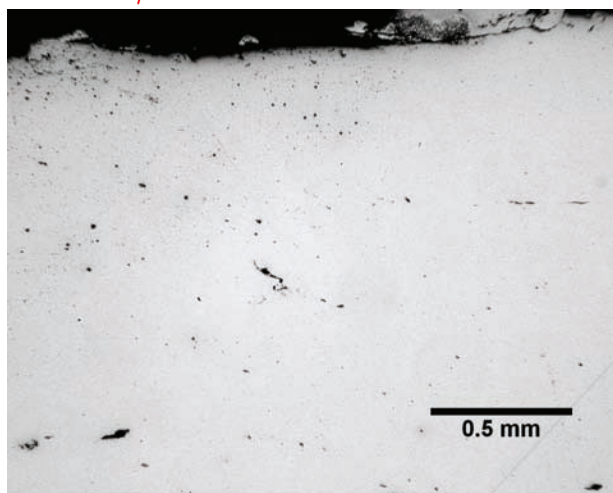
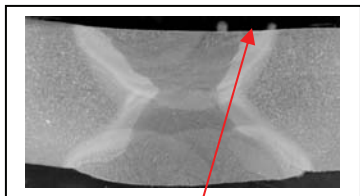

Right toe area at ID. Un-etched

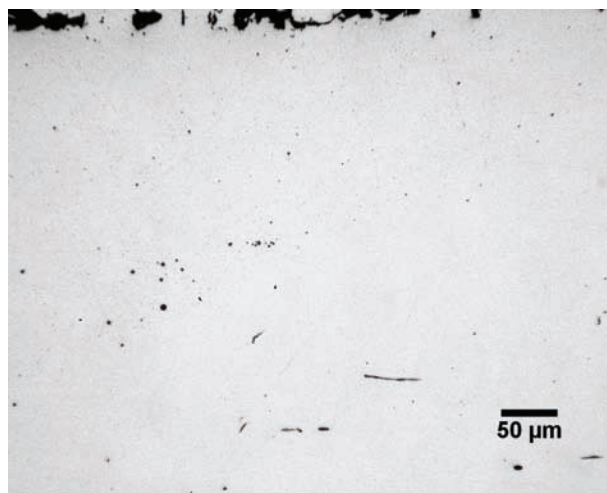

Right toe area at ID at higher magnification. Un-etched

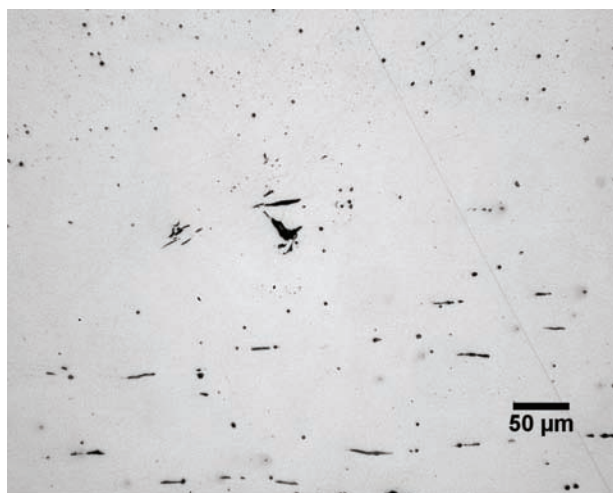

Right toe area somewhat farther from ID. Un-etched

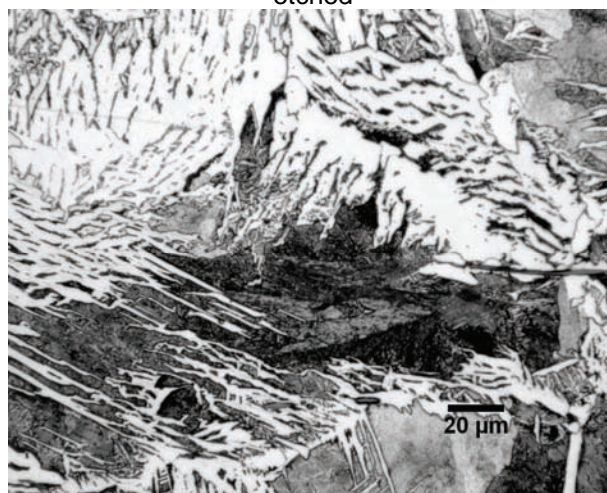

Right toe area at IDE. Etched

Figure 5. ID is on the top.

BETA LAB NO. M10198, REV. 1 - Tesoro E6600 HEAT EXCHANGER "E". SUMMARY OF THE RESULTS	TESORO REFINING AND MARKETING COMPANY ANACORTES REFINERY 10200 W. MARCH POINT ROAD T91WA4428 ANACORTES, WA 98221	CUSTOMER P.O. No.: 4501667904
PART: 6600-E HEAT EXCHANGER "E", ALL PARTS DAMAGE DEPTH, AND PART 17 MOUNTS		DATE: 3/7/2011
		PAGE 12 OF 70

**LABORATORY REPORT  
SAMPLE 17-LS1  
METALLOGRAPHY**

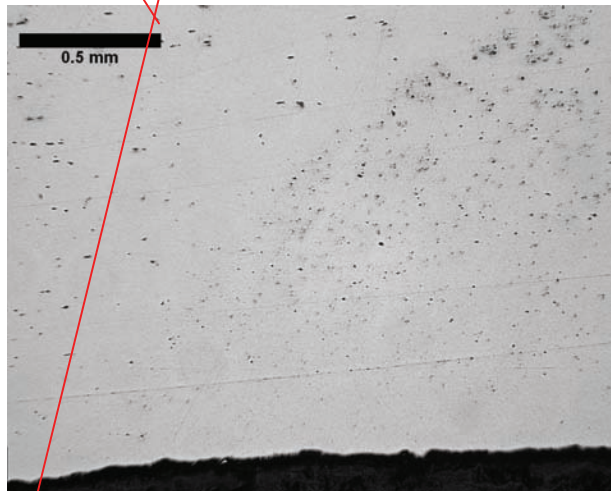
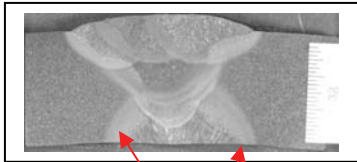

Left toe at the ID. Un-etched

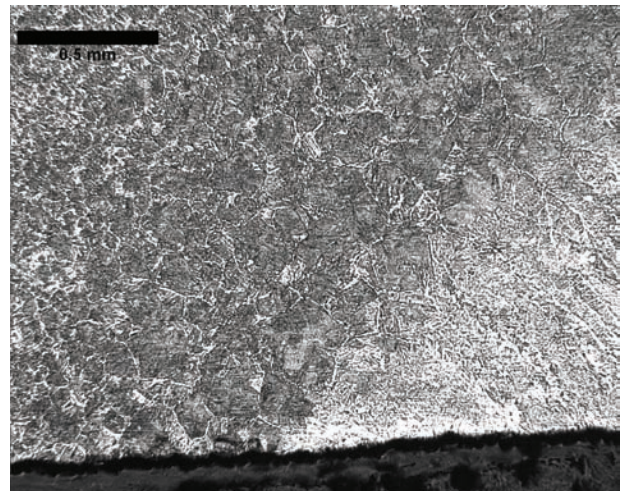

Same as on the left. Etched.

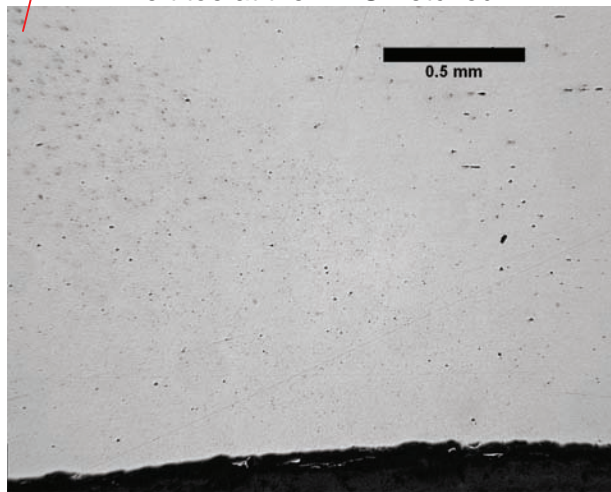

Right toe at the ID. Un-etched

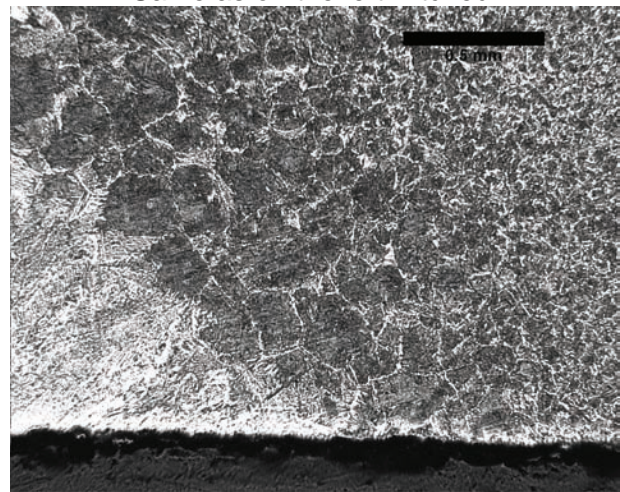

Same as on the left. Etched.

Figure 6. The ID is on the bottom.

BETA LAB NO. M10198, REV. 1 - Tesoro E6600 HEAT EXCHANGER "E". SUMMARY OF THE RESULTS	TESORO REFINING AND MARKETING COMPANY ANACORTES REFINERY 10200 W. MARCH POINT ROAD T91WA4428 ANACORTES, WA 98221	CUSTOMER P.O. No.: 4501667904 DATE: 3/7/2011 PAGE 13 OF 70
--	---	--

**LABORATORY REPORT**  
**SAMPLE 17 - LS1**  
**SEMI-MICRO HARDNESS DISTRIBUTION ACROSS THE WELD**

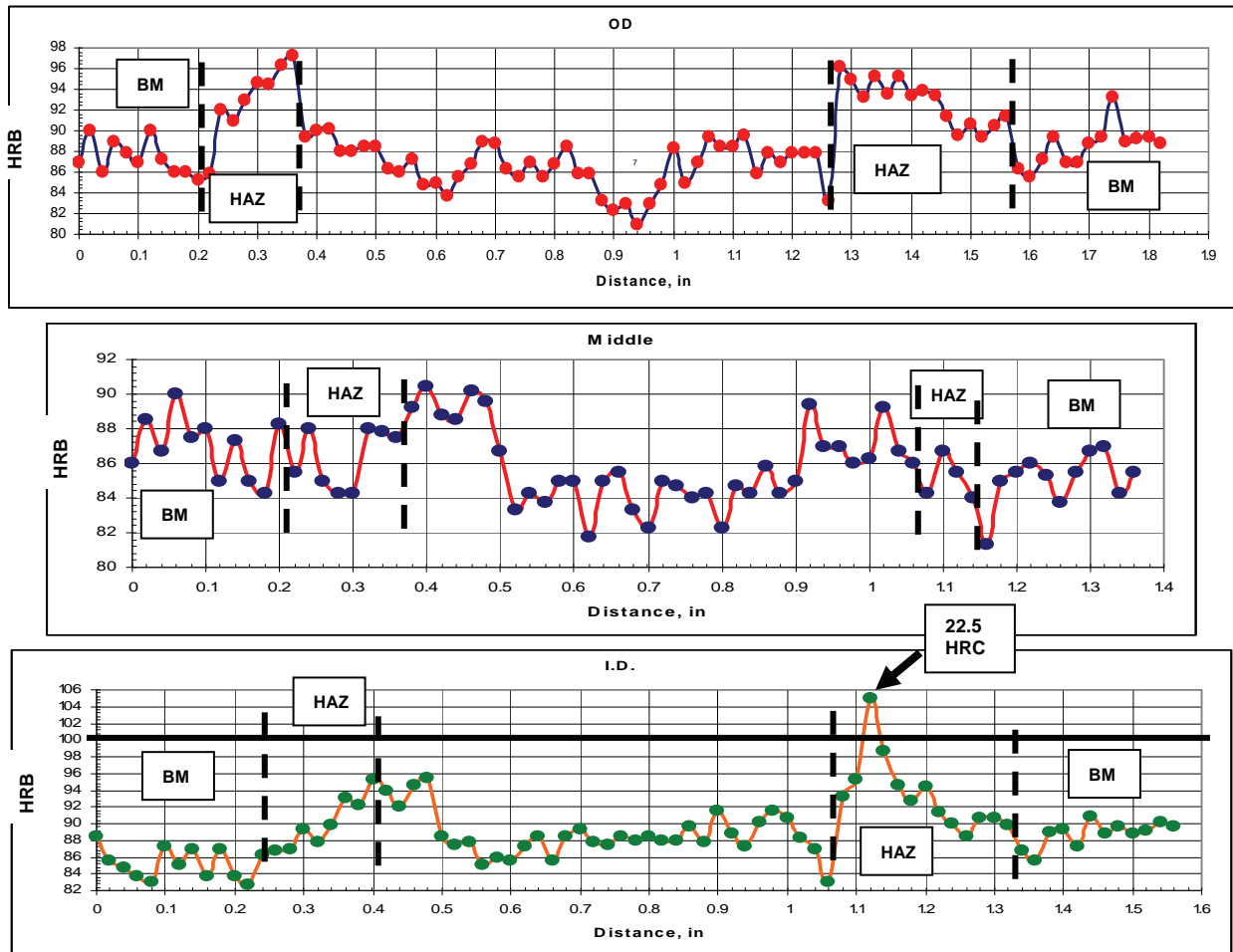
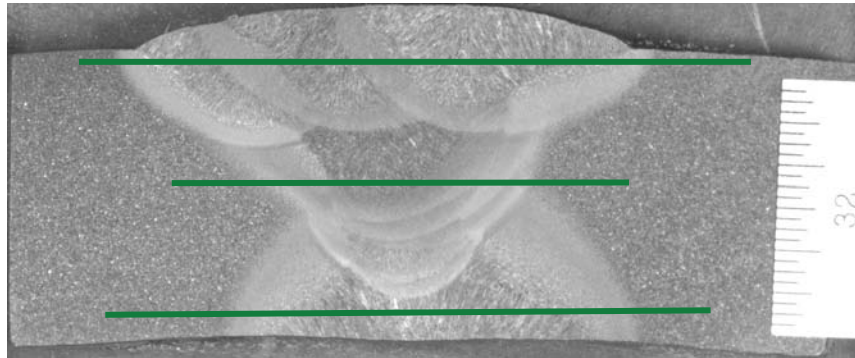

Figure 7. I.D. is on the bottom

BETA LAB NO.M10198, REV. 1 - Tesoro E6600 HEAT EXCHANGER "E". SUMMARY OF THE RESULTS  PART: 6600-E HEAT EXCHANGER "E", ALL PARTS DAMAGE DEPTH, AND PART 17 MOUNTS	TESORO REFINING AND MARKETING COMPANY ANACORTES REFINERY 10200 W. MARCH POINT ROAD T91WA4428 ANACORTES, WA 98221	CUSTOMER P.O. No.: 4501667904
		DATE: 3/7/2011
		PAGE 14 OF 70

**LABORATORY REPORT**  
**SAMPLE 17 - LS1**  
**HARDNESS DISTRIBUTION ACROSS THE WELD**

**TABLE 2**  
**TRAVERSE ACROSS WELD SEMI MICRO-HARDNESS TESTING**  
**OF 17-LS1 WELDED JOINT**  
**VICKERS<sup>500</sup> CONVERTED TO ROCKWELL SCALE B (HRB)**  
**See Figure 7 above for the graphic representation**

LOCATION		HARDNESS, HRB (CONVERTED FROM HV <sup>500</sup> )			NUMBER OF INDENTATIONS
		MINIMUM	MAXIMUM	AVERAGE	
O.D. LINE	BASE METAL CAN 1	85	90	87	24
	HAZ CAN 1	86	97	NA	23
	WELD METAL LS1	81	90	87	45
MIDDLE LINE	BASE METAL CAN 1	81	90	86	23
	HAZ CAN 1	84	88	NA	10
	WELD METAL LS1	82	90	86	36
I.D. LINE	BASE METAL CAN 1	83	91	87	24
	HAZ CAN 1	86	22.5HRC	NA	22
	WELD METAL LS1	83	96	89	33

BETA LAB NO.M10198, REV. 1 - Tesoro E6600 HEAT EXCHANGER "E". SUMMARY OF THE RESULTS	TESORO REFINING AND MARKETING COMPANY ANACORTES REFINERY 10200 W. MARCH POINT ROAD T91WA4428 ANACORTES, WA 98221	CUSTOMER P.O. No.: 4501667904
PART: 6600-E HEAT EXCHANGER "E", ALL PARTS DAMAGE DEPTH, AND PART 17 MOUNTS		DATE: 3/7/2011
		PAGE 15 OF 70

**LABORATORY REPORT**

**SUMMARY  
OF  
CHEMICAL  
AND  
MECHANICAL PROPERTIES**

BETA LAB NO.M10198, REV. 1 - Tesoro E6600 HEAT EXCHANGER "E". SUMMARY OF THE RESULTS  PART: 6600-E HEAT EXCHANGER "E", ALL PARTS DAMAGE DEPTH, AND PART 17 MOUNTS	TESORO REFINING AND MARKETING COMPANY ANACORTES REFINERY 10200 W. MARCH POINT ROAD T91WA4428 ANACORTES, WA 98221	CUSTOMER P.O. No.: 4501667904
		DATE: 3/7/2011
		PAGE 16 OF 70

## LABORATORY REPORT

**TABLE 3**  
**SUMMARY OF BASE METAL AND WELD DEPOSITS CHEMICAL ANALYSIS**

SAMPLE IDENTIFICATION		CHEMICAL COMPOSITION, WT. %											
		C	SI	P	S	MN	NI	CR	MO	V	CU	CO	AL
<b>BASE METAL</b>													
CAN1		0.28	0.24	0.01	0.024	0.62	0.12	0.13	0.03	<0.001	0.18	0.01	0.005
CAN 2		0.26	0.23	0.008	0.019	0.59	0.12	0.12	0.02	<0.001	0.18	0.01	0.01
CAN 3		0.26	0.23	0.008	0.021	0.60	0.12	0.13	0.02	<0.001	0.18	0.01	0.01
CAN 4		0.28	0.25	0.008	0.031	0.65	0.11	0.10	0.03	<0.001	0.13	0.01	0.005
CAN 4 CLAD		0.07	0.61	0.016	0.012	1.67	13.02	17.37	2.3	0.06	0.14	0.32	0.002
BUNDLE SUPPORT (ANGLES)		0.14	0.07	0.007	0.014	0.58	0.16	0.07	0.03	0.001	0.14	0.01	0.009
SA- 515 GRADE 70, JULY 2003 ADDENDUM		0.31	0.13- 0.45	0.035 MAX	0.035 MAX	1.30 MAX	NS	NS	NS	NS	NS	NS	NS
<b>WELD METAL</b>													
LS1	ID WELD SURFACE	0.13	0.46	0.011	0.021	1.12	0.08	0.09	0.02	0.001	0.04	0.01	0.006
	OD CROWN	0.07	0.59	0.012	0.017	1.18	0.05	0.07	0.01	0.002	0.14	0.01	0.005
CS2	ID WELD SURFACE	0.11	0.57	0.015	0.021	1.22	0.06	0.10	0.01	0.002	0.23	0.01	0.007
	OD CROWN	0.08	0.57	0.011	0.017	1.16	0.05	0.07	0.01	0.002	0.15	0.01	0.007
LS2	ID WELD SURFACE	0.12	0.54	0.011	0.018	1.15	0.05	0.07	0.01	0.002	0.14	0.01	0.010
	OD CROWN	0.08	0.49	0.011	0.021	1.12	0.07	0.08	0.02	0.001	0.04	0.01	0.005
CS3	ID WELD SURFACE	0.09	0.64	0.017	0.022	1.31	0.05	0.09	0.01	0.002	0.24	0.01	0.005
	OD CROWN	0.08	0.57	0.011	0.018	1.14	0.05	0.08	0.01	0.002	0.15	0.01	0.005
LS3	ID WELD SURFACE	0.16	0.37	0.010	0.021	1.04	0.08	0.09	0.02	0.001	0.14	0.01	0.005
	OD CROWN	0.10	0.50	0.011	0.019	1.12	0.06	0.08	0.01	0.001	0.14	0.01	0.005
CS4	ID WELD SURFACE	0.05	0.69	0.14	0.016	1.18	12.37	19.42	2.80	0.03	0.05	0.05	0
	OD CROWN	0.08	0.53	0.011	0.020	1.07	0.06	0.07	0.02	0.001	0.13	0.001	0.005
LS4	ID WELD SURFACE(S.S.)	0.03	0.78	0.014	0.019	0.89	13.27	19.05	2.92	0.05	0.07	0.08	0
	OD CROWN	0.07	0.53	0.011	0.021	1.13	0.06	0.07	0.01	0.001	0.13	0.007	0.006
SFA 5.1 (E7016, E7018)*		NS	0.75 MAX	NS	NS	1.60 MAX	0.30 MAX	0.20 MAX	0.30 MAX	0.08 MAX	NS	NS	NS
SFA 5.17 (EM11K)		0.07- 0.15	0.65- 0.85	0.030 MAX	0.025 MAX	1.00- 1.50	NS	NS	NS	NS	0.35	NS	NS
SFA 5.17 (EL12)		0.04- 0.14	0.10 MAX	0.030 MAX	0.030 MAX	0.25- 0.60	NS	NS	NS	NS	0.35	NS	NS
SFA 5.17 (EM12K)		0.05- 0.15	0.10- 0.35	0.030 MAX	0.030 MAX	0.80- 1.25	NS	NS	NS	NS	0.35	NS	NS

NO ALLOYS OR WELD WIRE GRADES WERE SPECIFIED SO TYPICAL ARE PRESENTED. \* TOTAL OF MN+NI+CR+MO+V 1.75 MAX  
 SFA 5.1 SPECIFICATION FOR CARBON STEEL ELECTRODES FOR SHIELD METAL ARC WELDING-JULY 2003 ADDENDUM  
 SFA 5.17 SPECIFICATION FOR CARBON STEEL ELECTRODES AND FLUXES FOR SUBMERGED ARC WELDING- JULY 2003 ADDENDUM  
 NS = NOT SPECIFIED



BETA LAB NO.M10198, REV. 1 - Tesoro E6600 HEAT EXCHANGER "E". SUMMARY OF THE RESULTS  PART: 6600-E HEAT EXCHANGER "E", ALL PARTS DAMAGE DEPTH, AND PART 17 MOUNTS	TESORO REFINING AND MARKETING COMPANY ANACORTES REFINERY 10200 W. MARCH POINT ROAD T91WA4428 ANACORTES, WA 98221	CUSTOMER P.O. No.: 4501667904
		DATE: 3/7/2011
		PAGE 17 OF 70

**LABORATORY REPORT**

**TABLE 4**  
**SUMMARY OF**  
**ROCKWELL HARDNESS,**  
**SCALE B (HRB) AT THE PLATES CROSS SECTION**

TEST OBJECT	HARDNESS, HRB			NUMBER OF INDENTATIONS
	MINIMUM	MAXIMUM	AVERAGE	
CAN 1	81.4	84.4	82.7	7
CAN 2	82.3	83.5	83.1	7
CAN 3	82.5	83.7	83.1	7
CAN 4	79.3	80.2	79.8	7

**TABLE 5**  
**SUMMARY OF TRAVERSE**  
**SEMI MICRO-HARDNESS TESTING ACROSS WELD**  
**VICKERS<sup>500</sup> CONVERTED TO ROCKWELL SCALE B (HRB)**

TEST OBJECT		HARDNESS HRB (CONVERTED FROM VICKERS <sup>500</sup> )			
		MINIMUM	MAXIMUM	AVERAGE	
BM	CAN 1	79	92	87	
	CAN2	86	93	90	
	CAN3*	73	80	77	
		87	96	92	
	CAN4	76	84	80	
CIRCUMFERENTIAL WELDS	HAZ	CAN 1	83	20HRC	NA
		CAN2	88	20HRC	NA
		CAN3	85	97	NA
		CAN4	76	97	NA
	WM	CS2	76	93	86
		CS3	89	93	90
		CS4*	73	78	75
			84	21HRC	94

\*BM Can3 and WM CS4 hardness data were split into two sets because a deviation of the test results was noticed.

BETA LAB NO.M10198, REV. 1 - Tesoro E6600 HEAT EXCHANGER "E". SUMMARY OF THE RESULTS  PART: 6600-E HEAT EXCHANGER "E", ALL PARTS DAMAGE DEPTH, AND PART 17 MOUNTS	TESORO REFINING AND MARKETING COMPANY ANACORTES REFINERY 10200 W. MARCH POINT ROAD T91WA4428 ANACORTES, WA 98221	CUSTOMER P.O. No.: 4501667904
		DATE: 3/7/2011
		PAGE 18 OF 70

**LABORATORY REPORT**

**TABLE 5 (continued)**  
**SUMMARY OF TRAVERSE**  
**SEMI MICRO-HARDNESS TESTING ACROSS WELD**  
**VICKERS<sup>500</sup> CONVERTED TO ROCKWELL SCALE B (HRB)**

TEST OBJECT			HARDNESS HRB (CONVERTED FROM VICKERS 500g)		
			MINIMUM	MAXIMUM	AVERAGE
<b>LONGITUDINAL WELDS</b>	<b>HAZ</b>	CAN1	85	22.5HRC	NA
		CAN2	88	98	NA
		CAN3	92	98	NA
		CAN4	85	97	NA
	<b>WM</b>	LS1	82	92	87
		LS2	84	92	89
		LS3*	74	79	77
			88	23HRC	96
		LS4	81	87	84

\* WM LS3 hardness data were split into two sets because a deviation of the test results was noticed.

**TABLE 6**  
**ROOM TENSILE TESTING OF BASE METAL**

SAMPLE ID	MECHANICAL PROPERTIES (RANGE ABOVE THE LINE AND AVERAGE BELOW THE LINE)			
	TENSILE K.S.I	YIELD K.S.I	ELONGATION %	REDUCED AREA %
CAN 1	77 – 76.5	42.6 – 41.9	27 – 27	51 - 52
	77	42	27	51.5
CAN 2	72.5- 72	41 – 38.9	29 – 29	55 – 54
	72.5	40	29	54.5
CAN 3	75.5 – 75	45.2 – 45.7	26 – 28	52 – 52
	75	45.5	27	52
CAN 4	74 – 73.5	42.4 – 41.6	26 – 27	49 - 52
	74	42	26.5	50.5
SA 515 GR. 70	70 - 90	38 MIN.	17 MIN	21 MIN

BETA LAB NO.M10198, REV. 1 - Tesoro E6600 HEAT EXCHANGER "E". SUMMARY OF THE RESULTS  PART: 6600-E HEAT EXCHANGER "E", ALL PARTS DAMAGE DEPTH, AND PART 17 MOUNTS	TESORO REFINING AND MARKETING COMPANY ANACORTES REFINERY 10200 W. MARCH POINT ROAD T91WA4428 ANACORTES, WA 98221	CUSTOMER P.O. No.: 4501667904
		DATE: 3/7/2011
		PAGE 19 OF 70

## LABORATORY REPORT

TABLE 7  
**ROOM TENSILE TESTING OF WELDED JOINTS**

WELD ID	MECHANICAL PROPERTIES (RANGE ABOVE THE LINE AND AVERAGE BELOW THE LINE)				
	TENSILE	YIELD	ELONGATION %	FAILURE LOCATION	TYPE OF FAILURE
LS1	77.5 – 78.5	55.5 – 55.5	20 - 22	BASE METAL	DUCTILE
	78	55.5	21		
LS2	68.5 – 74.5	56.5 – 55	7.5 – 14	WELD METAL - HAZ	DUCTILE
	71.5	56	11		
CS2	76 – 76	47.1 – 42	29 – 29	BASE METAL	DUCTILE
	76	47.5	29		
CS3	66.5 – 65.5	58.5 – 58	12 - 12	WELD METAL	DUCTILE
	66	58	12		

TABLE 8  
**BEND TESTS OF WELDING JOINTS**

WELD ID		TEST RESULTS
LS1	SAMPLE 1	PASSED
	SAMPLE 2	PASSED
LS2	SAMPLE 1	PASSED
	SAMPLE 2	PASSED
CS2	SAMPLE 1	PASSED
	SAMPLE 2	PASSED
CS3	SAMPLE 1	*FAILED>1/8 INCH CRACK @ 90°
	SAMPLE 2	*FAILED>1/8 INCH CRACK @ 90°
* ACCEPTANCE CRITERIA QW-163 ASME SECTION IX QUALIFICATION STANDARD FOR WELDING AND BRAZING PROCEDURES, WELDERS, BRAZERS, AND WELDING AND BRAZING PROCEDURES – JULY 2003 ADDENDUM		

BETA LAB NO. M10198, REV. 1 - Tesoro E6600 HEAT EXCHANGER "E". SUMMARY OF THE RESULTS  PART: 6600-E HEAT EXCHANGER "E", ALL PARTS DAMAGE DEPTH, AND PART 17 MOUNTS	TESORO REFINING AND MARKETING COMPANY ANACORTES REFINERY 10200 W. MARCH POINT ROAD T91WA4428 ANACORTES, WA 98221	CUSTOMER P.O. No.: 4501667904
		DATE: 3/7/2011
		PAGE 20 OF 70

## LABORATORY REPORT

**TABLE 9**  
**IMPACT TESTING RESULTS OF BASE METAL**  
 See graphical representation of the data on Figure 8 next page

TEST TEMPERATURE °F, AND SAMPLE NO.	SAMPLE ID AND TEST RESULTS												
	LS1			LS2			CS3			CS4			
	FT-LB	LAT. EXP. MILS	% SHEAR	FT-LB	LAT. EXP. MILS	% SHEAR	FT-LB	LAT. EXP. MILS	% SHEAR	FT-LB	LAT. EXP. MILS	% SHEAR	
120	1	26	19	50	33	29	70	30	27	60	33	31	80
	2	29	25	70	30	30	60	27	22	50	32	27	80
	3	27	23	70	32	33	80	29	24	60	35	30	80
	<b>AVERAGE</b>	<b>27</b>	<b>22</b>	<b>63</b>	<b>32</b>	<b>31</b>	<b>70</b>	<b>29</b>	<b>24</b>	<b>57</b>	<b>33</b>	<b>29</b>	<b>80</b>
90	1	22	20	20	23	21	20	22	23	20	27	26	30
	2	19	14	10	24	23	20	22	21	20	27	28	30
	<b>AVERAGE</b>	<b>21</b>	<b>17</b>	<b>15</b>	<b>24</b>	<b>22</b>	<b>20</b>	<b>22</b>	<b>22</b>	<b>20</b>	<b>27</b>	<b>27</b>	<b>30</b>
60	1	16	12	20	20	17	20	22	14	20	19	13	20
	2	17	16	20	18	15	20	18	13	20	19	15	20
	3	7	5	20	12	7	20	15	8	20	22	14	20
	<b>AVERAGE</b>	<b>13</b>	<b>11</b>	<b>20</b>	<b>17</b>	<b>13</b>	<b>20</b>	<b>18</b>	<b>12</b>	<b>20</b>	<b>20</b>	<b>14</b>	<b>20</b>
20	1	9	1	10	6	1	10	14	7	10	10	5	10
	2	6	4	10	5	1	10	9	3	10	7	2	10
	3	10	3	10	7	2	10	12	6	10	6	2	10
	<b>AVERAGE</b>	<b>8</b>	<b>3</b>	<b>10</b>	<b>6</b>	<b>1</b>	<b>10</b>	<b>12</b>	<b>5</b>	<b>10</b>	<b>8</b>	<b>3</b>	<b>10</b>
0	1	8	3	0	11	7	0	5	1	0	5	1	0
	2	11	5	0	5	2	0	5	1	0	5	0	0
	3	7	2	0	8	1	0	6	1	0	11	5	0
	<b>AVERAGE</b>	<b>9</b>	<b>3</b>	<b>0</b>	<b>8</b>	<b>3</b>	<b>0</b>	<b>5</b>	<b>1</b>	<b>0</b>	<b>7</b>	<b>2</b>	<b>0</b>
-20	1	6	0	0	7	1	0	8	1	0	5	0	0
	2	9	4	0	7	1	0	5	1	0	2	0	0
	3	8	2	0	5	1	0	5	2	0	6	1	0
	<b>AVERAGE</b>	<b>8</b>	<b>2</b>	<b>0</b>	<b>6</b>	<b>1</b>	<b>0</b>	<b>6</b>	<b>1</b>	<b>0</b>	<b>4</b>	<b>0</b>	<b>0</b>

BETA LAB NO.M10198, REV. 1 - Tesoro E6600  
HEAT EXCHANGER "E". SUMMARY OF THE RESULTS  
PART: 6600-E HEAT EXCHANGER "E", ALL PARTS  
DAMAGE DEPTH, AND PART 17 MOUNTS

TESORO REFINING AND MARKETING COMPANY  
ANACORTES REFINERY  
10200 W. MARCH POINT ROAD T91WA4428  
ANACORTES, WA 98221

CUSTOMER P.O. No.: 4501667904

DATE: 3/7/2011

PAGE 21 OF 70

**LABORATORY REPORT**

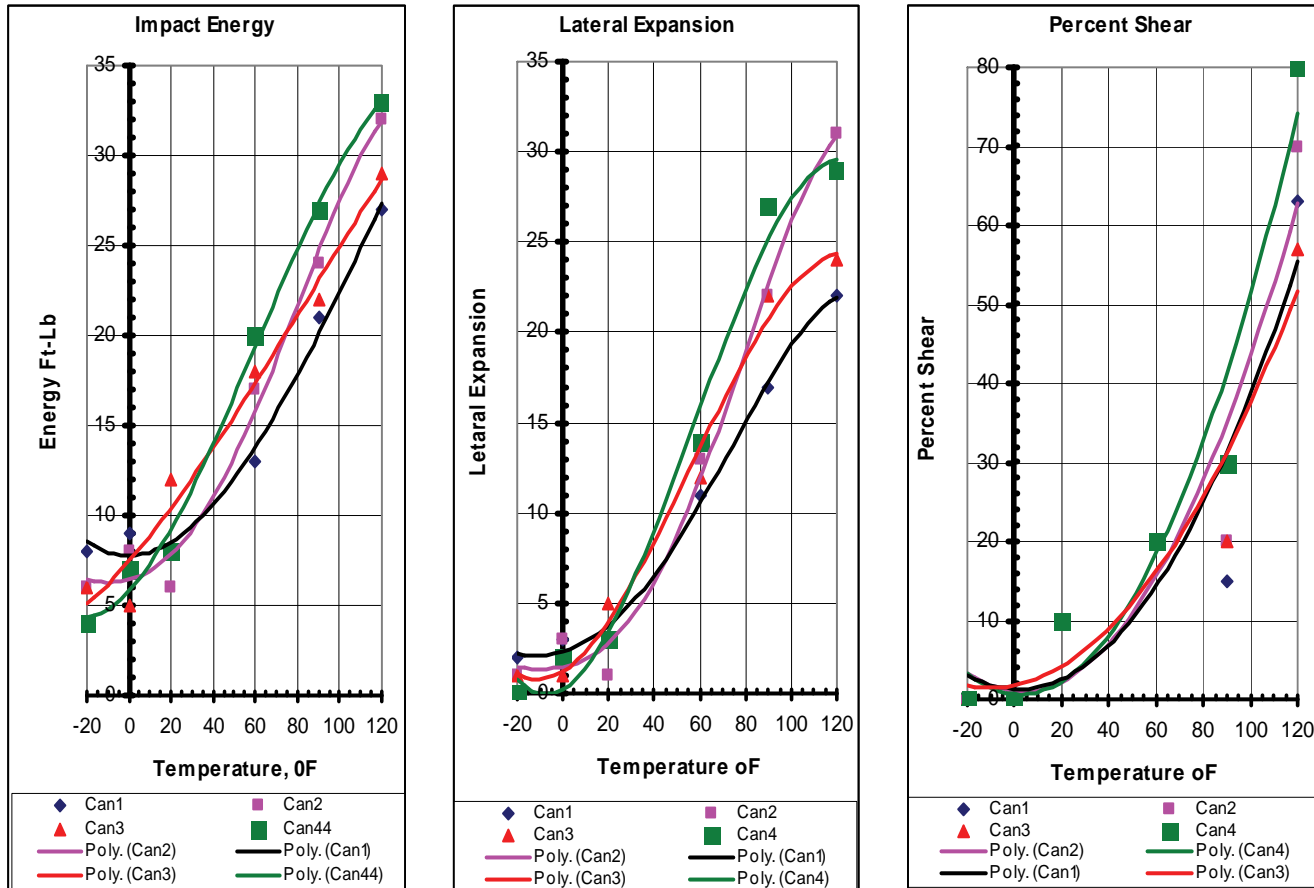

Figure 8. Impact testing results at indicated temperatures. Base metal. See Table 8 on previous page for the details.

**TABLE 10**  
**Impact Testing of the Weld Metal**

Temperature (°F) and Sample No		Sample ID											
		17 CS2			16-1 CS3			16-2 LS2			17 LS1		
		Ft-Lb	Lat. Exp. mils	% shear	Ft-Lb	Lat. Exp. mils	% shear	Ft-Lb	Lat. Exp. mils	% shear	Ft-Lb	Lat. Exp. mils	% shear
0	1	33	24	40	36	29	30	33	30	30	39	34	30
	2	33	32	40	33	22	30	33	26	30	42	28	30
	3	36	33	40	41	31	30	33	26	30	45	41	30
	Average	34	30	40	37	27	30	33	27	30	42	34	30

BETA LAB NO.M10198, REV. 1 - Tesoro E6600 HEAT EXCHANGER "E". SUMMARY OF THE RESULTS	TESORO REFINING AND MARKETING COMPANY ANACORTES REFINERY 10200 W. MARCH POINT ROAD T91WA4428 ANACORTES, WA 98221	CUSTOMER P.O. No.: 4501667904
PART: 6600-E HEAT EXCHANGER "E", ALL PARTS DAMAGE DEPTH, AND PART 17 MOUNTS		DATE: 3/7/2011
		PAGE 22 OF 70

**LABORATORY REPORT**

**SUMMARY  
OF THE DATA  
ON  
THE DEPTH OF THE DAMAGE  
AND  
DAMAGE LOCATION**

BETA LAB NO.M10198, REV. 1 - Tesoro E6600 HEAT EXCHANGER "E". SUMMARY OF THE RESULTS	TESORO REFINING AND MARKETING COMPANY ANACORTES REFINERY 10200 W. MARCH POINT ROAD T91WA4428 ANACORTES, WA 98221	CUSTOMER P.O. No.: 4501667904
PART: 6600-E HEAT EXCHANGER "E", ALL PARTS DAMAGE DEPTH, AND PART 17 MOUNTS		DATE: 3/7/2011
PAGE 23 OF 70		

**LABORATORY REPORT**

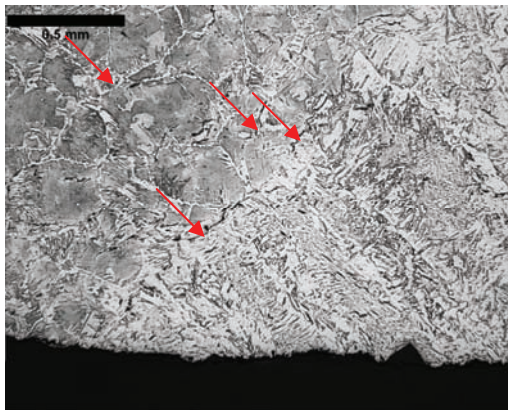

A

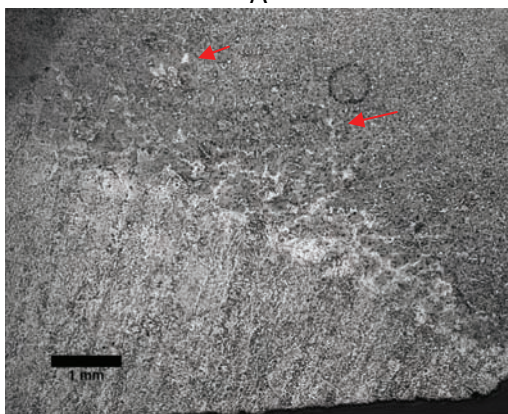

B

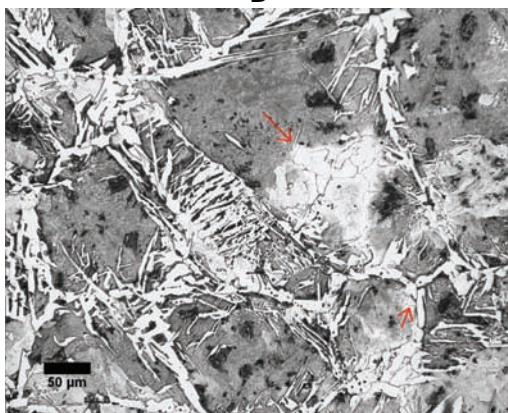

C

When the observed damage is located at the fusion line (FL) or at the 1<sup>st</sup> or 2<sup>nd</sup> grain of the CG HAZ (Coarse Grain of the Heat Affected Zone, CG everywhere in this report), it is marked as **"FL"**

It is typical to find damage beyond the FL and the 2<sup>nd</sup> grain of the CG, as it shown on the micrographs at left. The arrows at the microphotograph [B] show a spot indicative of the damage well deep in the CG, away from the FL. On microphotograph [C] the damage is in the 21<sup>st</sup> – 22<sup>nd</sup> grain inside the CG.

If this is observed, the location of the damage is defined as **"CG"**.

If both, fusion line and coarse grain area are affected (which is most often the case), the location is defined as **"FL/CG"**

Figure 9. Definitions of the damage locations (devised by others) used in Table 11 and in the text. The locations in the base metal (BM) or in the weld metal (WM) are self-explanatory.

BETA LAB No.M10198, REV. 1 - Tesoro E6600 HEAT EXCHANGER "E". SUMMARY OF THE RESULTS	TESORO REFINING AND MARKETING COMPANY ANACORTES REFINERY 10200 W. MARCH POINT ROAD T91WA4428 ANACORTES, WA 98221	CUSTOMER P.O. No.: 4501667904
PART: 6600-E HEAT EXCHANGER "E", ALL PARTS DAMAGE DEPTH, AND PART 17 MOUNTS		DATE: 3/7/2011
		PAGE 24 OF 70

**LABORATORY REPORT**

**TABLE 11**  
**DEPTH AND LOCATION OF THE DAMAGE**

WELD AND PART NUMBER	LOCATION OF TH SAMPLES	SAMPLE LABEL	DAMAGE DEPTH FROM ID				DAMAGE LOCATION		WIDTH AT THE DEEPEST DAMAGE, MM				MICROGRAPHS ON FIGURE No.		
			LEFT OF WELD		RIGHT OF WELD		LEFT OF WELD	RIGHT OF WELD	COARSE GRAIN HAZ	FINE GRAIN HAZ	LEFT OF WELD	RIGHT OF WELD			
			MM	%*	MM	%*								LEFT OF WELD	RIGHT OF WELD
CS4 AND LS4 PARTS 19E AND 19W (20) + MATCHING MOUNTS PARTS 14 AND 18		19W-m1	18.51	85	3	0 (CLAD)	0	4	FL	NA	UD	NA	UD	NA	10
		19W-m2	0 (CLAD)	NA	4	17.73	81	3	NA	FL	NA	NA	NA	NA	11
		19W-m3	0 (CLAD)	0	4	0 (CLAD)	0	4	NA	NA	NA	NA	NA	NA	12
		19E-m4	0 (CLAD)	0	4	9.91	45	3	NA	BM	NA	NA	0.75	NA	13
		19E-m5/14-m5	0 (CLAD)	0	4	18.8 (19Em5) 21.8 (14-m5)	86 100	3	NA	WM 19Em5 BM 14-m5	NA	NA	NA	NA	NA

UD – UNDEFINED  
 \* SEE NOTE AT THE END OF THE TABLE 11, ON PAGE 29



BETA LAB No.M10198, REV. 1 - Tesoro E6600 HEAT EXCHANGER "E". SUMMARY OF THE RESULTS	TESORO REFINING AND MARKETING COMPANY ANACORTES REFINERY 10200 W. MARCH POINT ROAD T91WA4428 ANACORTES, WA 98221	CUSTOMER P.O. No.: 4501667904
PART: 6600-E HEAT EXCHANGER "E", ALL PARTS DAMAGE DEPTH, AND PART 17 MOUNTS		DATE: 3/7/2011
		PAGE 25 OF 70

**LABORATORY REPORT**

**TABLE 11**

**DEPTH AND LOCATION OF THE DAMAGE (CONTINUED)**

WELD AND PART NUMBER	LOCATION OF TH SAMPLES	SAMPLE LABEL	DAMAGE DEPTH FROM ID				DAMAGE LOCATION		WIDTH AT THE DEEPEST DAMAGE, MM				MICROGRAPHS ON FIGURE NO.		
			LEFT OF WELD		RIGHT OF WELD		LEFT OF WELD	RIGHT OF WELD	COARSE GRAIN HAZ		FINE GRAIN HAZ				
	MACRO PHOTOS		MM	%*	CAN	MM	%*	CAN	LEFT OF WELD	RIGHT OF WELD	LEFT OF WELD	RIGHT OF WELD	LEFT OF WELD	RIGHT OF WELD	
CS4 AND LS4 PARTS 19E AND 19W (20) + MATCHING MOUNTS		19E-18-m3/18-m3	0	0	4	19.98	91.7	3	NA	WM/FL	NA	NA	NA	3.62	15
			(CLAD)			21.8	100		CG						
PARTS 14 AND 18 (CONTINUED)		18-m1	4.98	23	3	5.53	25	3	BM	BM	NA	NA	NA	NA	16
			Left Leg		Area under fillet weld	Right Leg		Area under fillet weld							
LS3 AND CS3 BOTTOM PART 14 + MATCHING MOUNTS		18-m2	9.32	43	3	9.86	45	3	BM	BM	NA	NA	NA	NA	17
			Left Leg		Area under fillet weld	Right Leg		Area under fillet weld							
TOP PART 15		14-m1	1.96	9	3	3.19	15	2	FL	FL	0.56	0.83	0.80	1.49	18-19
TOP PART 15		14-m2	2.54	12	3	1.23	6	2	FL/CG	CG	0.49	1.42	1.15	1.72	20

\* SEE NOTE AT THE END OF THE TABLE 11, ON PAGE 29

BETA LAB No.M10198, REV. 1 - Tesoro E6600 HEAT EXCHANGER "E". SUMMARY OF THE RESULTS	TESORO REFINING AND MARKETING COMPANY ANACORTES REFINERY 10200 W. MARCH POINT ROAD T91WA4428 ANACORTES, WA 98221	CUSTOMER P.O. No.: 4501667904
PART: 6600-E HEAT EXCHANGER "E", ALL PARTS DAMAGE DEPTH, AND PART 17 MOUNTS		DATE: 3/7/2011
		PAGE 26 OF 70

**LABORATORY REPORT**

**TABLE 11**

**DEPTH AND LOCATION OF THE DAMAGE (CONTINUED)**

WELD AND PART NUMBER	LOCATION OF TH SAMPLES	SAMPLE LABEL	DAMAGE DEPTH FROM ID				DAMAGE LOCATION		WIDTH AT THE DEEPEST DAMAGE, MM				MICROGRAPHS ON FIGURE NO.		
			LEFT OF WELD		RIGHT OF WELD		LEFT OF WELD	RIGHT OF WELD	COARSE GRAIN HAZ		FINE GRAIN HAZ				
			MM	%*	CAN	MM			%*	CAN	LEFT OF WELD	RIGHT OF WELD		LEFT OF WELD	RIGHT OF WELD
LS3 AND CS3 BOTTOM PART 14 + MATCHING MOUNTS LS3 TOP PART 15 (CONTINUED)		14-m3/15-m3	12.94	59	3	17.2	79	CG	FL/CG	0.85	NA	1.32	NA	21^	
			14-m3			5.54	25	CG	FL/CG	14m3	14m3	14m3	14m3		
			14-m3			15m3					15m3	15m3	15m3		
			21.8	100	3	14.28	66	WM	BM	NA	NA	NA	NA		22
			14-m4T			15-m4T									
			20.91	96	3	21.8	100	CG	CG	CG	CG	0.16	0.7		0
14-T0/15-T0			21.8	100											
		14-m6	3.37	15	2	7.29	33	FG	BM	1.75	1.02	1.71	1.67	25	

\* SEE NOTE AT THE END OF THE TABLE 11, ON PAGE 29

^ DUE TO SPECIFIC LOCATION OF THE SAW CUT THE FRACTURE LINE OF THE SAMPLE 15-M3 DOES NOT REFLECT THE MATCHING LINE OF THE SAMPLE 14-M3. ONLY 14-M3 MICROPHOTOGRAPHS ARE SHOWN ON FIGURE 21.  
 UD - UNDEFINED

BETA LAB No.M10198, REV. 1 - Tesoro E6600 HEAT EXCHANGER "E". SUMMARY OF THE RESULTS	TESORO REFINING AND MARKETING COMPANY ANACORTES REFINERY 10200 W. MARCH POINT ROAD T91WA4428 ANACORTES, WA 98221	CUSTOMER P.O. No.: 4501667904
PART: 6600-E HEAT EXCHANGER "E", ALL PARTS DAMAGE DEPTH, AND PART 17 MOUNTS		DATE: 3/7/2011
		PAGE 27 OF 70

**LABORATORY REPORT**

**TABLE 11  
 DEPTH AND LOCATION OF THE DAMAGE (CONTINUED)**

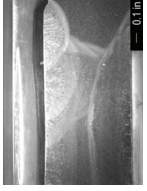
LOCATION OF TH SAMPLES		SAMPLE LABEL	DAMAGE DEPTH FROM ID						DAMAGE LOCATION				WIDTH AT THE DEEPEST DAMAGE, MM				MICROGRAPHS ON FIGURE NO.
			LEFT OF WELD		RIGHT OF WELD		LEFT OF WELD	RIGHT OF WELD	LEFT OF WELD	RIGHT OF WELD	LEFT OF WELD	RIGHT OF WELD	LEFT OF WELD	RIGHT OF WELD	LEFT OF WELD	RIGHT OF WELD	
			MM	%*	CAN	MM											
WELD AND PART NUMBER	MACRO PHOTOS   PART1 ALLY LS2 AND CS3	T-2	No damage	2	5.66	26	3	No HAZ	No HAZ	FL/CG /FG	No HAZ	No HAZ	No HAZ	No HAZ	0.227	0.060	26
		LS2-CS3 TEE, PART 16-1	T-2C^	19.9	2	0.344	2	3	CG	CG	CG	0.88	0.94	0.56	0.82	0.89	27
			LS2	5.85	2	7.45	34	2	FL/CG	BM	NONE	0.82	0.73	0.99	0.73	28	

\* SEE NOTE AT THE END OF THE TABLE 11, ON PAGE 29  
 ^ SEE EXPLANATION FOR THE CHANGE AT PAGE 1

BETA LAB No.M10198, REV. 1 - Tesoro E6600 HEAT EXCHANGER "E". SUMMARY OF THE RESULTS	TESORO REFINING AND MARKETING COMPANY ANACORTES REFINERY 10200 W. MARCH POINT ROAD T91WA4428 ANACORTES, WA 98221	CUSTOMER P.O. No.: 4501667904
PART: 6600-E HEAT EXCHANGER "E", ALL PARTS DAMAGE DEPTH, AND PART 17 MOUNTS		DATE: 3/7/2011
		PAGE 28 OF 70

**LABORATORY REPORT**

**TABLE 11**

**DEPTH AND LOCATION OF THE DAMAGE (CONTINUED)**

WELD AND PART NUMBER	LOCATION OF TH SAMPLES	SAMPLE LABEL	DAMAGE DEPTH FROM ID				DAMAGE LOCATION		WIDTH AT THE DEEPEST DAMAGE, MM				MICROGRAPHS ON FIGURE NO.		
			LEFT OF WELD		RIGHT OF WELD		LEFT OF WELD	RIGHT OF WELD	COARSE GRAIN HAZ		FINE GRAIN HAZ				
			MM	%* CAN	MM	%* CAN	LEFT OF WELD	RIGHT OF WELD	LEFT OF WELD	RIGHT OF WELD	LEFT OF WELD	RIGHT OF WELD			
LS2 PART 16-2		LS2-22"	3.04	14	2	5.37	25	2	CG	FL	4.09	1.82	1.08	4.20	29
			3.18	15	2	0	0	2	FL	NA	2.50	1.64	3.88	2.47	30
LS2/CS2 TEE PART 22		LS2-A	1.38	6	2	2.11	10	2	FL	CG	1.62	1.98	1.90	1.46	31
			0	0	1	4.05	19	2	NA	CG	NA	NA	1.54	1.25	32

\* SEE NOTE AT THE END OF THE TABLE 11, ON PAGE 29

BETA LAB No.M10198, REV. 1 - Tesoro E6600 HEAT EXCHANGER "E". SUMMARY OF THE RESULTS	TESORO REFINING AND MARKETING COMPANY ANACORTES REFINERY 10200 W. MARCH POINT ROAD T91WA4428 ANACORTES, WA 98221	CUSTOMER P.O. No.: 4501667904
PART: 6600-E HEAT EXCHANGER "E", ALL PARTS DAMAGE DEPTH, AND PART 17 MOUNTS		DATE: 3/7/2011
		PAGE 29 OF 70

**LABORATORY REPORT**

**TABLE 11**  
**DEPTH AND LOCATION OF THE DAMAGE (CONTINUED)**

LOCATION OF TH SAMPLES		SAMPLE LABEL	DAMAGE DEPTH FROM ID				DAMAGE LOCATION		WIDTH AT THE DEEPEST DAMAGE, MM				MICROGRAPHS ON FIGURE NO.								
			LEFT OF WELD		RIGHT OF WELD		LEFT OF WELD	RIGHT OF WELD	COARSE GRAIN HAZ		FINE GRAIN HAZ										
			MM	%*	MM	%*			LEFT OF WELD	RIGHT OF WELD	LEFT OF WELD	RIGHT OF WELD									
WELD AND PART NUMBER	MACRO PHOTOS	LS-1	0	0	0	0	1	0	0	1	0	0	1	0	0	1	NA	NA	NA	NA	33-34
			0	0	0	0	1	0	1	0	0	1	0	0	1	0	0	1	NA	NA	NA

\* The thicknesses of the individual mounts were not measured but rather an average 21.8 mm wall thickness was utilized to calculate the percent of wall for the maximum depth of damage. The maximum depth of damage was determined at 50x magnification as seen through the eyepiece in the un-etched condition. Any clarification of the damage was performed at 200x magnification as seen through the eye piece.

BETA LAB NO.M10198, REV. 1 - Tesoro E6600 HEAT EXCHANGER "E". SUMMARY OF THE RESULTS	TESORO REFINING AND MARKETING COMPANY ANACORTES REFINERY 10200 W. MARCH POINT ROAD T91WA4428 ANACORTES, WA 98221	CUSTOMER P.O. No.: 4501667904
PART: 6600-E HEAT EXCHANGER "E", ALL PARTS DAMAGE DEPTH, AND PART 17 MOUNTS		DATE: 3/7/2011
		PAGE 30 OF 70

**LABORATORY REPORT**

**MICRO-PHOTOGRAPHS  
OF THE AREAS  
WITH THE DEEPEST  
DAMAGE FOUND**

BETA LAB NO.M10198, REV. 1 - Tesoro E6600 HEAT EXCHANGER "E". SUMMARY OF THE RESULTS	TESORO REFINING AND MARKETING COMPANY ANACORTES REFINERY 10200 W. MARCH POINT ROAD T91WA4428 ANACORTES, WA 98221	CUSTOMER P.O. No.: 4501667904
PART: 6600-E HEAT EXCHANGER "E", ALL PARTS DAMAGE DEPTH, AND PART 17 MOUNTS		DATE: 3/7/2011
		PAGE 31 OF 70

**LABORATORY REPORT  
CS4 WELD, SAMPLE 19W-M1**

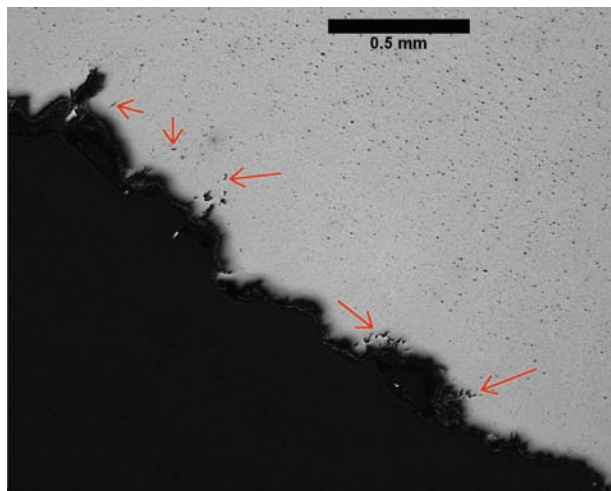
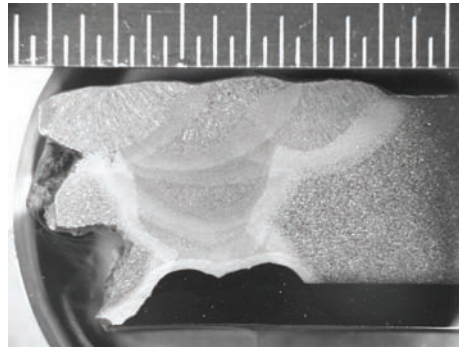

Un-etched left of weld

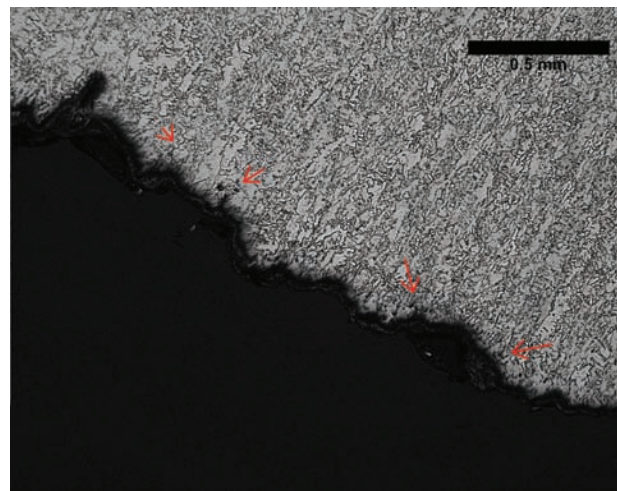

Etched left of weld

Damage Depth, mm	
Left of the Weld	Right of the Weld
18.51	0 (Clad)

Figure 10. OD is on the top.

BETA LAB NO.M10198, REV. 1 - Tesoro E6600 HEAT EXCHANGER "E". SUMMARY OF THE RESULTS	TESORO REFINING AND MARKETING COMPANY ANACORTES REFINERY 10200 W. MARCH POINT ROAD T91WA4428 ANACORTES, WA 98221	CUSTOMER P.O. No.: 4501667904
PART: 6600-E HEAT EXCHANGER "E", ALL PARTS DAMAGE DEPTH, AND PART 17 MOUNTS		DATE: 3/7/2011
		PAGE 32 OF 70

**LABORATORY REPORT**

**CS4 WELD, SAMPLE 19W-M2**

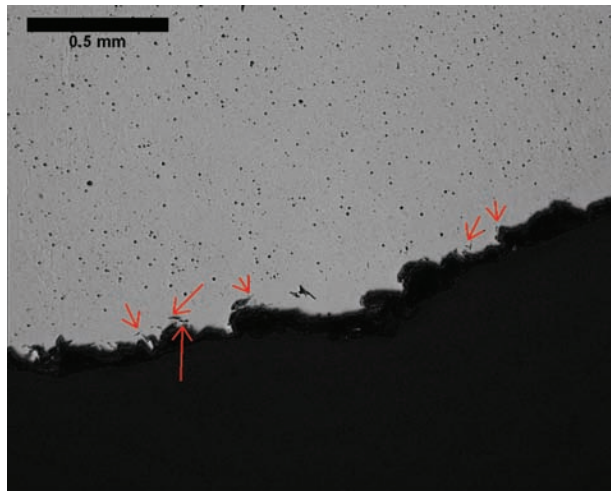
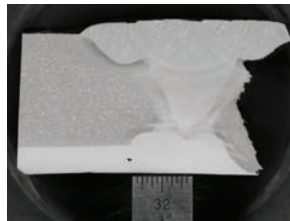

Un-etched- right side of weld

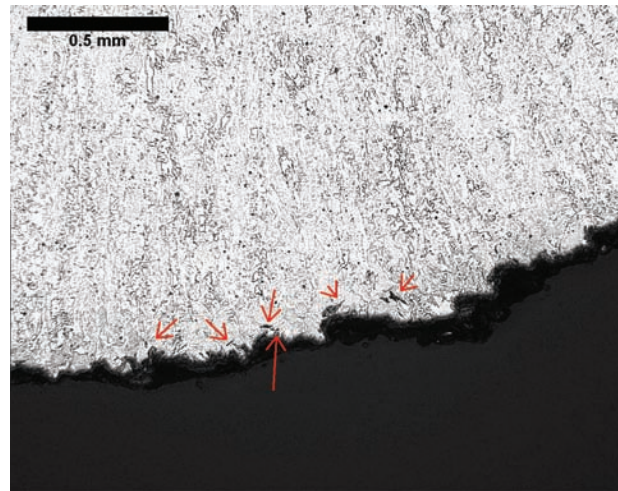

Etched- right side of weld

Damage Depth, mm	
Left of Weld	Right of Weld
0 (Clad)	17.73

Figure 11. OD is on the top.



BETA LAB NO.M10198, REV. 1 - Tesoro E6600 HEAT EXCHANGER "E". SUMMARY OF THE RESULTS	TESORO REFINING AND MARKETING COMPANY ANACORTES REFINERY 10200 W. MARCH POINT ROAD T91WA4428 ANACORTES, WA 98221	CUSTOMER P.O. No.: 4501667904
PART: 6600-E HEAT EXCHANGER "E", ALL PARTS DAMAGE DEPTH, AND PART 17 MOUNTS		DATE: 3/7/2011
		PAGE 33 OF 70

**LABORATORY REPORT**

**LS4 WELD, SAMPLE 19W-M3**

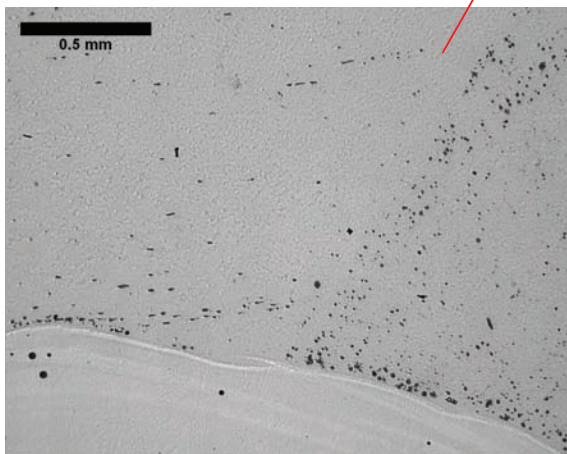
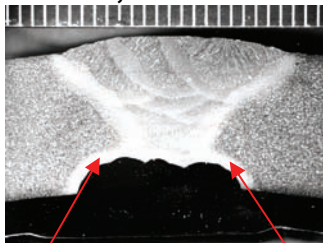

Left of weld. Un-etched

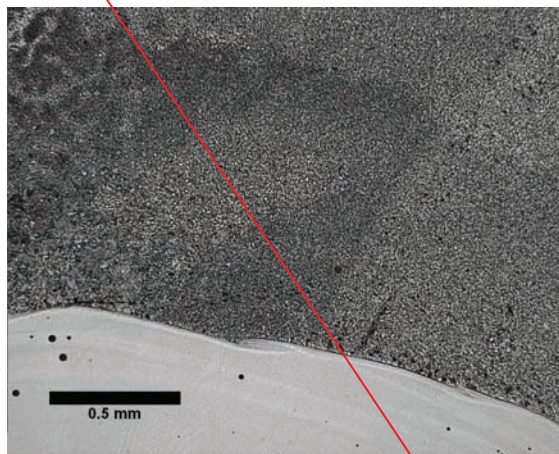

Left of weld. Etched

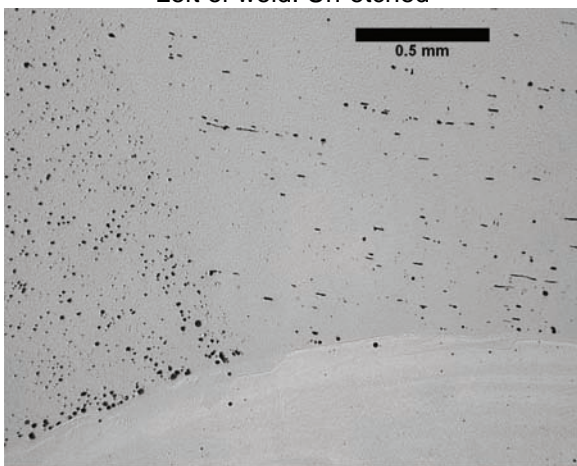

Right of weld. Un-etched

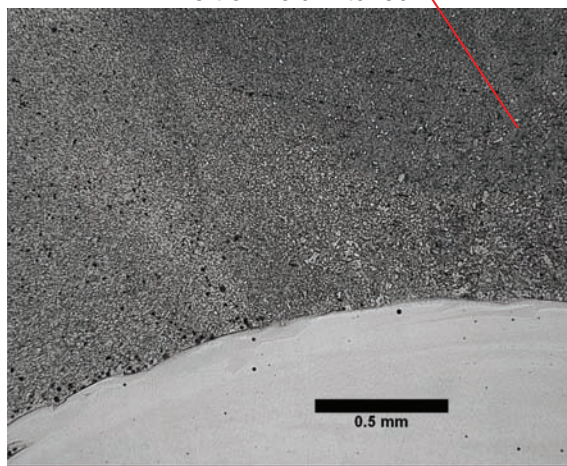

Right of weld. Etched

Damage Depth, mm	
Left of Weld	Right of Weld
0 (Clad)	

Figure 12. OD is on the top.

BETA LAB NO.M10198, REV. 1 - Tesoro E6600  
HEAT EXCHANGER "E". SUMMARY OF THE RESULTS  
PART: 6600-E HEAT EXCHANGER "E", ALL PARTS  
DAMAGE DEPTH, AND PART 17 MOUNTS

TESORO REFINING AND MARKETING COMPANY  
ANACORTES REFINERY  
10200 W. MARCH POINT ROAD T91WA4428  
ANACORTES, WA 98221

CUSTOMER P.O. No.: 4501667904  
DATE: 3/7/2011  
PAGE 34 OF 70

**LABORATORY REPORT**

**CS4 WELD, SAMPLE 19E-M4**

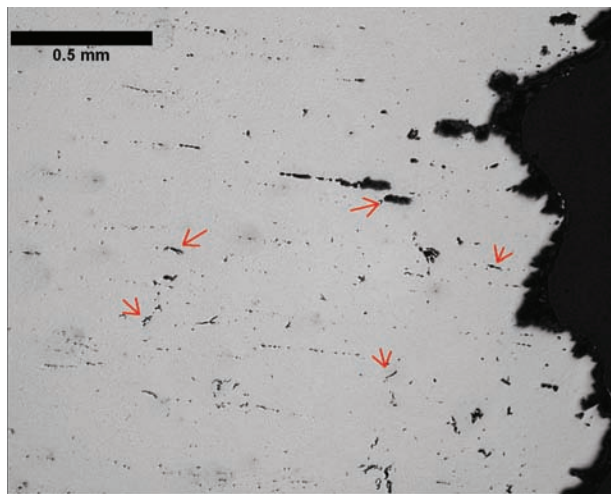
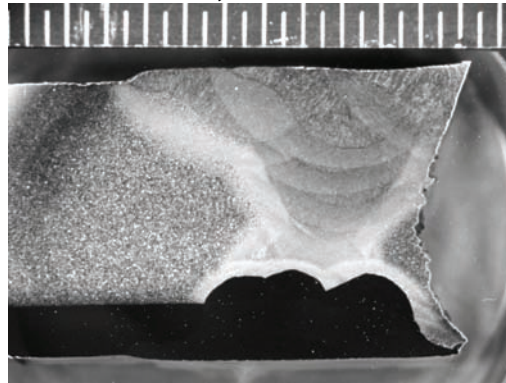

Right. Un-etched

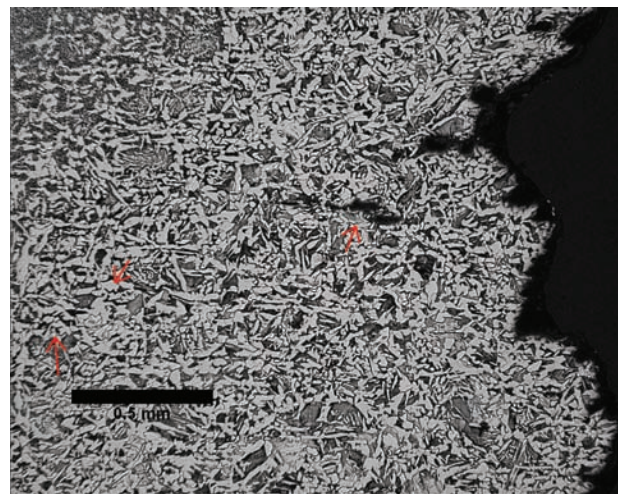

Right. Etched

Damage Depth, mm	
Left of Weld	Right of Weld
0 (Clad)	9.91

Figure 13. OD is on the top.

BETA LAB NO.M10198, REV. 1 - Tesoro E6600  
 HEAT EXCHANGER "E". SUMMARY OF THE RESULTS  
 PART: 6600-E HEAT EXCHANGER "E", ALL PARTS  
 DAMAGE DEPTH, AND PART 17 MOUNTS

TESORO REFINING AND MARKETING COMPANY  
 ANACORTES REFINERY  
 10200 W. MARCH POINT ROAD T91WA4428  
 ANACORTES, WA 98221

CUSTOMER P.O. No.: 4501667904  
 DATE: 3/7/2011  
 PAGE 35 OF 70

**LABORATORY REPORT**  
**CS4 WELD, SAMPLE 19E-M5/14-M5**

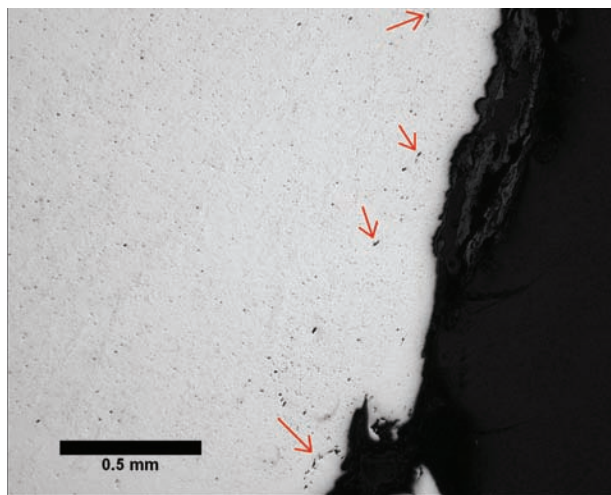
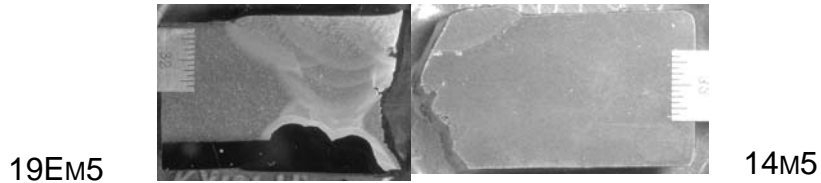

19E-m5 at fracture. Un-etched

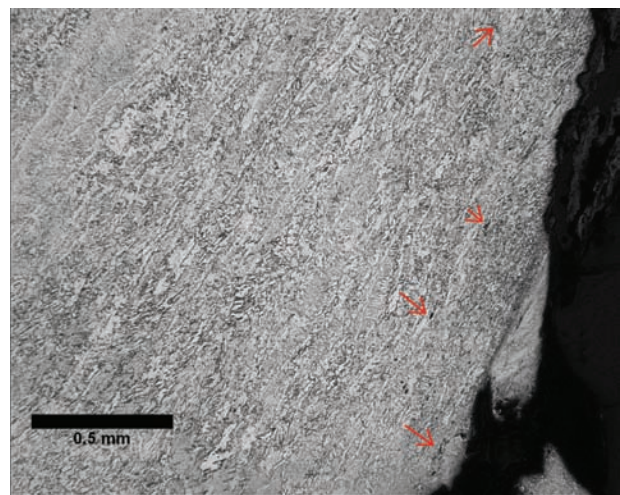

19E-m5 at fracture. Etched

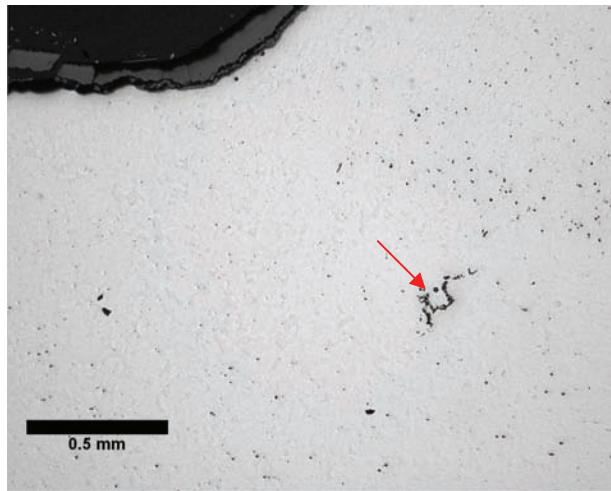

14-m5 at O.D. Un-etched.

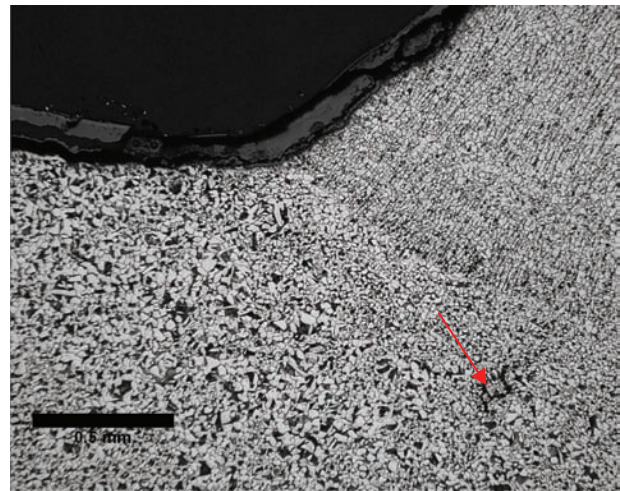

14-m5 at O.D. Etched

Damage Depth, mm	
Left of Weld	Right of Weld
0 (Clad)	21.8

Figure 14. OD is on the top.

BETA LAB NO. M10198, REV. 1 - Tesoro E6600 HEAT EXCHANGER "E". SUMMARY OF THE RESULTS	TESORO REFINING AND MARKETING COMPANY ANACORTES REFINERY 10200 W. MARCH POINT ROAD T91WA4428 ANACORTES, WA 98221	CUSTOMER P.O. No.: 4501667904
PART: 6600-E HEAT EXCHANGER "E", ALL PARTS DAMAGE DEPTH, AND PART 17 MOUNTS	DATE: 3/7/2011 PAGE 36 OF 70	

**LABORATORY REPORT**

**CS4 WELD, SAMPLE 19E-18-M3/18-M3**

19E-18m3

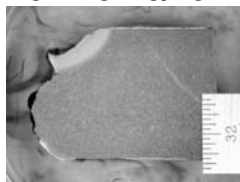
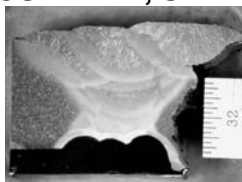

18-m3

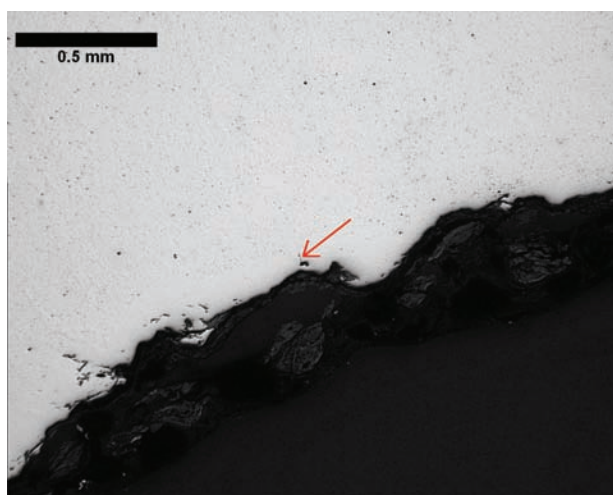

19E-18-m3 at fracture. Un-etched

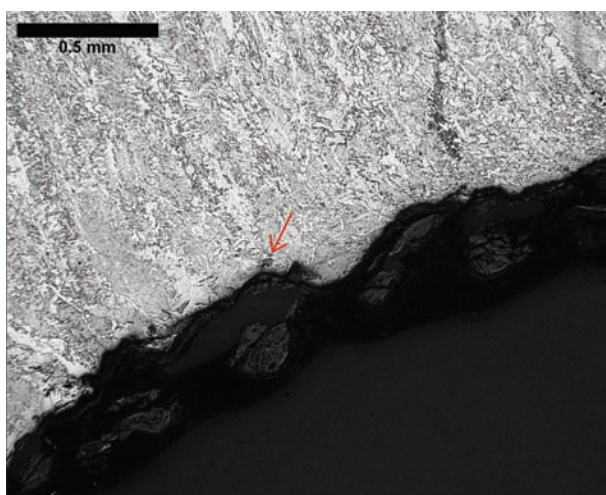

19E-18-m3 at fracture. Etched

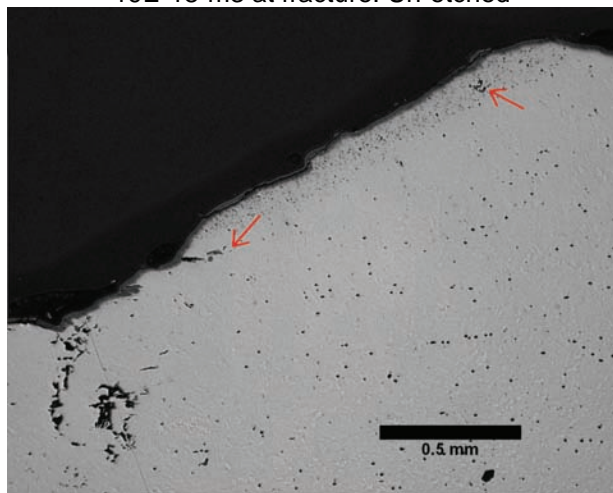

18-m3 at fracture, at OD. Un-etched

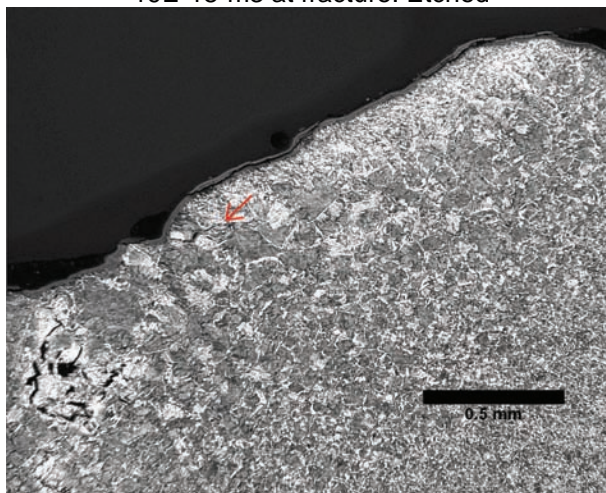

18-m3 at fracture, at OD. Etched

Damage Depth	
Left of Weld	Right of Weld
0 (Clad)	21.8

Figure 15. OD is on the top.

BETA LAB NO.M10198, REV. 1 - Tesoro E6600 HEAT EXCHANGER "E". SUMMARY OF THE RESULTS	TESORO REFINING AND MARKETING COMPANY ANACORTES REFINERY 10200 W. MARCH POINT ROAD T91WA4428 ANACORTES, WA 98221	CUSTOMER P.O. No.: 4501667904
PART: 6600-E HEAT EXCHANGER "E", ALL PARTS DAMAGE DEPTH, AND PART 17 MOUNTS		DATE: 3/7/2011
		PAGE 37 OF 70

**LABORATORY REPORT**

**CS4 WELD, SAMPLE 18-M1**

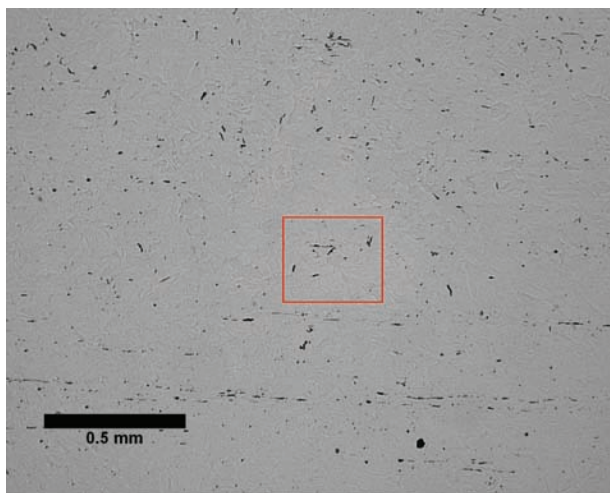
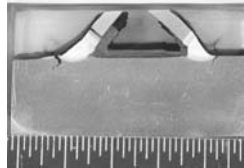

Area under left weld. Un-etched

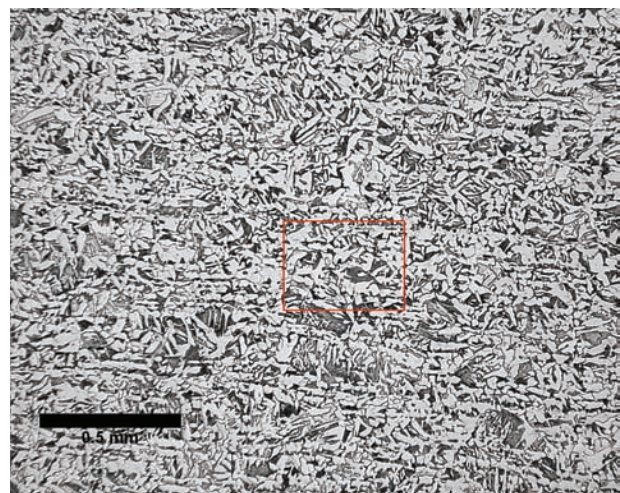

Area under left weld. Etched

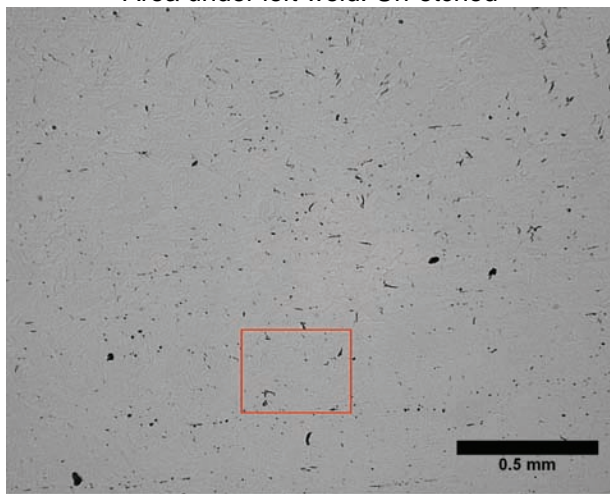

Area under right weld. Un-etched

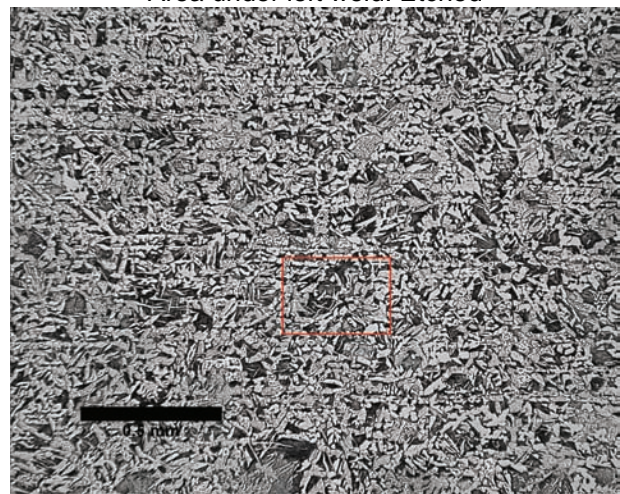

Area under right weld. Etched

Damage Depth, mm	
Left of Weld	Right of Weld
4.98	5.53

Figure 16. ID is on the top.

BETA LAB NO.M10198, REV. 1 - Tesoro E6600 HEAT EXCHANGER "E". SUMMARY OF THE RESULTS	TESORO REFINING AND MARKETING COMPANY ANACORTES REFINERY 10200 W. MARCH POINT ROAD T91WA4428 ANACORTES, WA 98221	CUSTOMER P.O. No.: 4501667904 DATE: 3/7/2011 PAGE 38 OF 70
---	---	--

**LABORATORY REPORT**

**CS4 WELD, SAMPLE 18-M2**

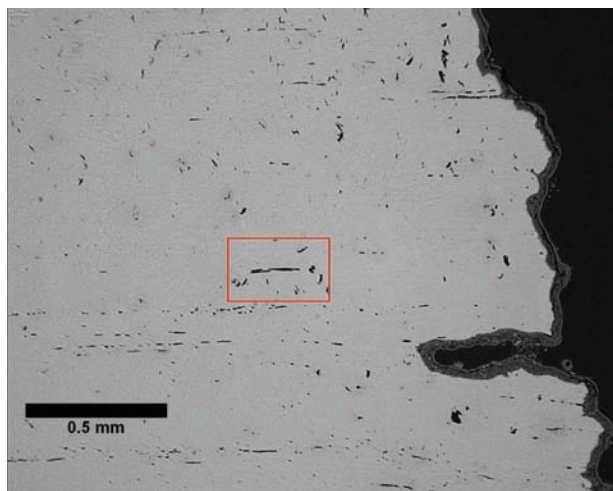
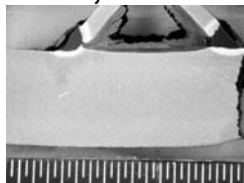

Area at fracture under right fillet weld Un-etched

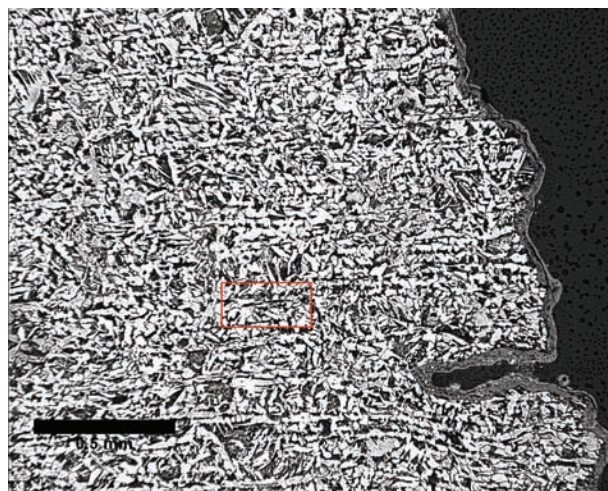

Area at fracture under right fillet weld. Etched

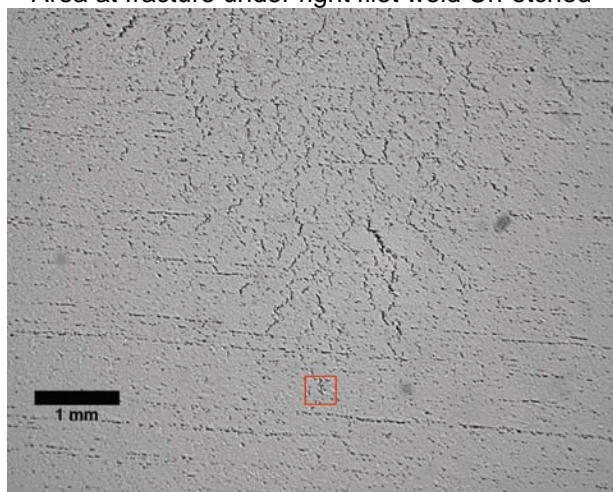

Area under left weld. Un-etched

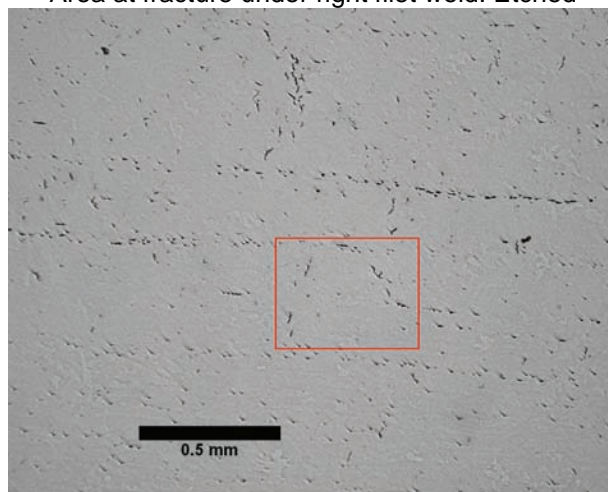

Area under left weld enlarged. Un-etched

Damage Depth, mm	
Left of Weld	Right of Weld
9.32	9.86

Figure 17. ID is on the top.

BETA LAB NO.M10198, REV. 1 - Tesoro E6600 HEAT EXCHANGER "E". SUMMARY OF THE RESULTS	TESORO REFINING AND MARKETING COMPANY ANACORTES REFINERY 10200 W. MARCH POINT ROAD T91WA4428 ANACORTES, WA 98221	CUSTOMER P.O. No.: 4501667904
PART: 6600-E HEAT EXCHANGER "E", ALL PARTS DAMAGE DEPTH, AND PART 17 MOUNTS		DATE: 3/7/2011
		PAGE 39 OF 70

**LABORATORY REPORT**

**CS3 WELD, SAMPLE 14-M1**

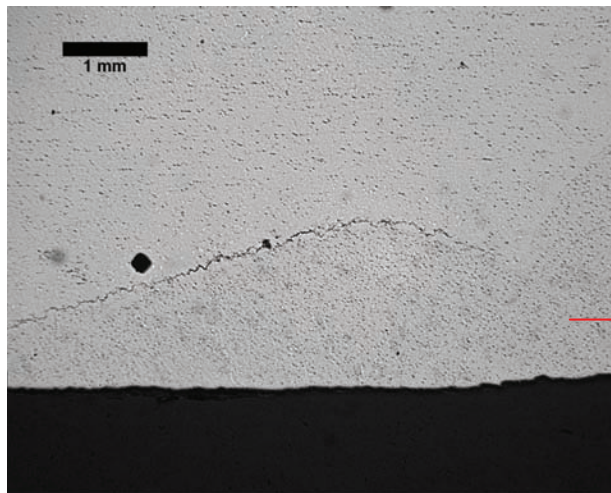
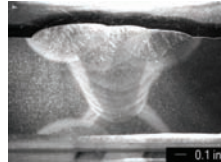

Un-etched

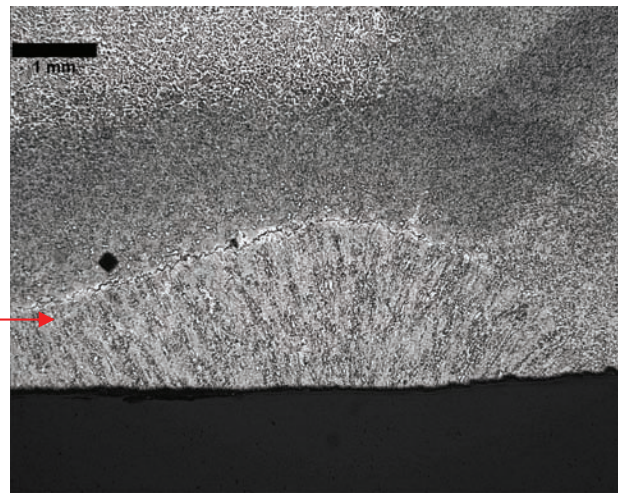

Etched

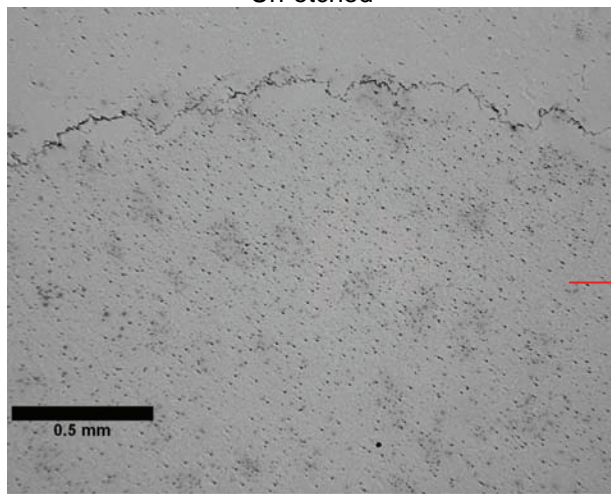

Detail of above -Un-etched

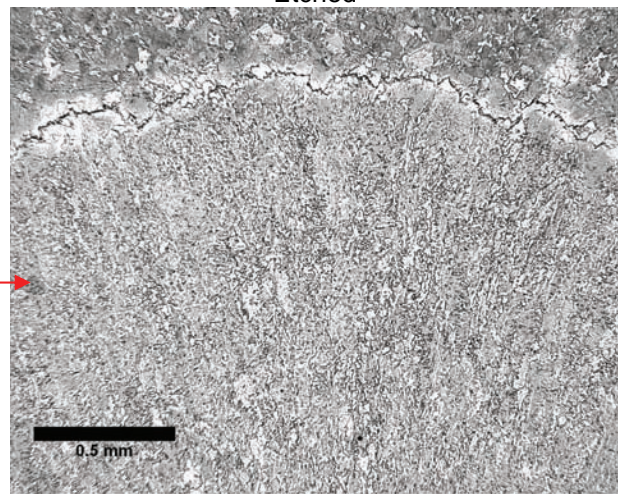

Detail of above-Etched

Damage Depth, mm
Left of Weld
1.96

Figure 18. Damaged area left of the weld. OD is on the top.

BETA LAB NO.M10198, REV. 1 - Tesoro E6600  
HEAT EXCHANGER "E". SUMMARY OF THE RESULTS  
PART: 6600-E HEAT EXCHANGER "E", ALL PARTS  
DAMAGE DEPTH, AND PART 17 MOUNTS

TESORO REFINING AND MARKETING COMPANY  
ANACORTES REFINERY  
10200 W. MARCH POINT ROAD T91WA4428  
ANACORTES, WA 98221

CUSTOMER P.O. No.: 4501667904

DATE: 3/7/2011

PAGE 40 OF 70

**LABORATORY REPORT**

**CS3 WELD, SAMPLE 14-M1**

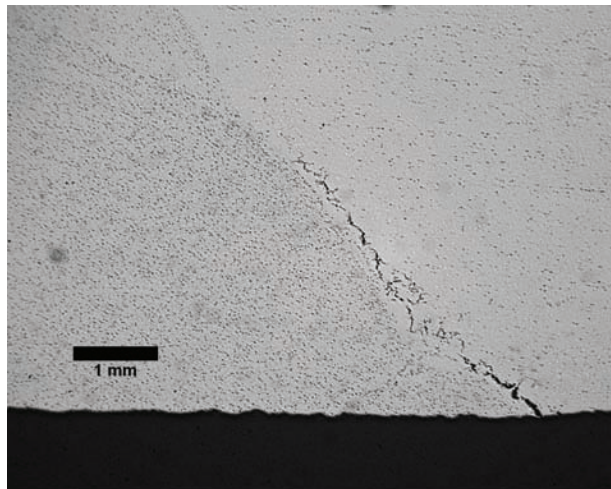
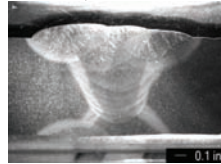

Un-etched

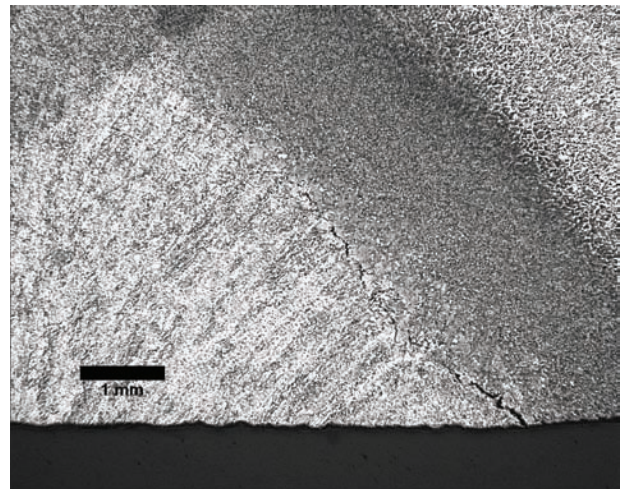

Etched

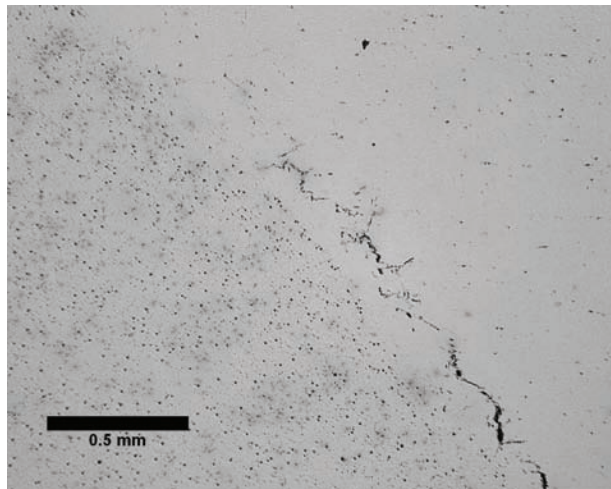

Detail of above-Un-etched

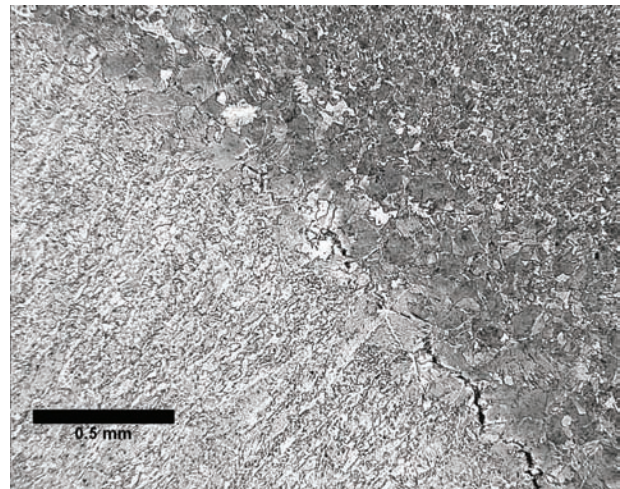

Detail of above-Etched

Damage Depth, mm
Right of Weld
3.19

Figure 19. Damaged area right of the weld. OD is on the top.



BETA LAB NO.M10198, REV. 1 - Tesoro E6600 HEAT EXCHANGER "E". SUMMARY OF THE RESULTS	TESORO REFINING AND MARKETING COMPANY ANACORTES REFINERY 10200 W. MARCH POINT ROAD T91WA4428 ANACORTES, WA 98221	CUSTOMER P.O. No.: 4501667904
PART: 6600-E HEAT EXCHANGER "E", ALL PARTS DAMAGE DEPTH, AND PART 17 MOUNTS		DATE: 3/7/2011
		PAGE 41 OF 70

**LABORATORY REPORT  
CS3 WELD, SAMPLE 14-M2**

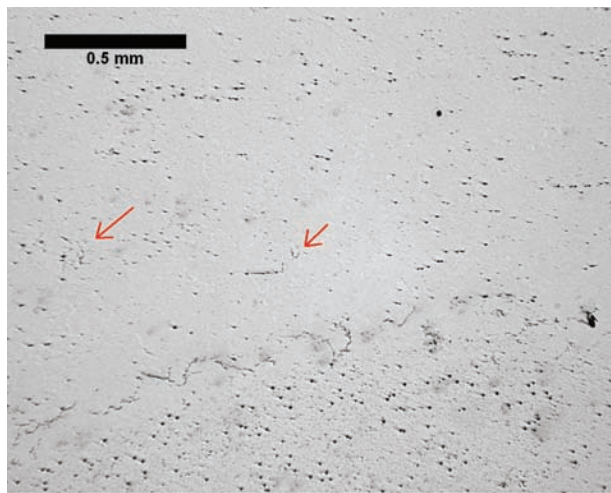
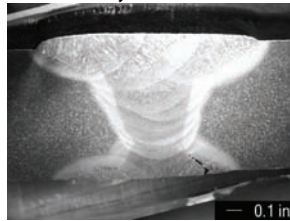

Left of Weld. Un-etched

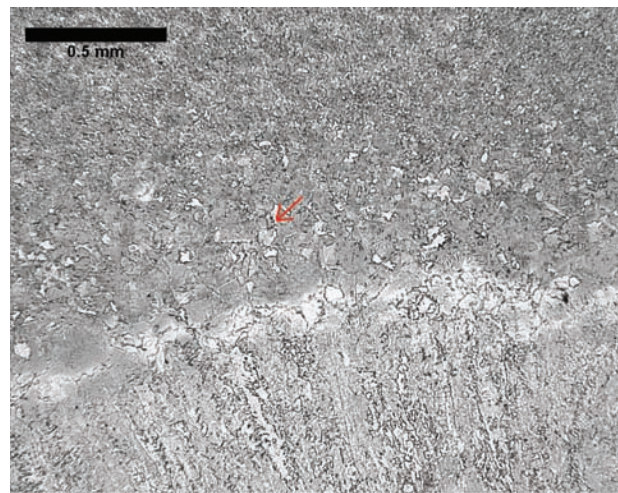

Left of Weld. Etched

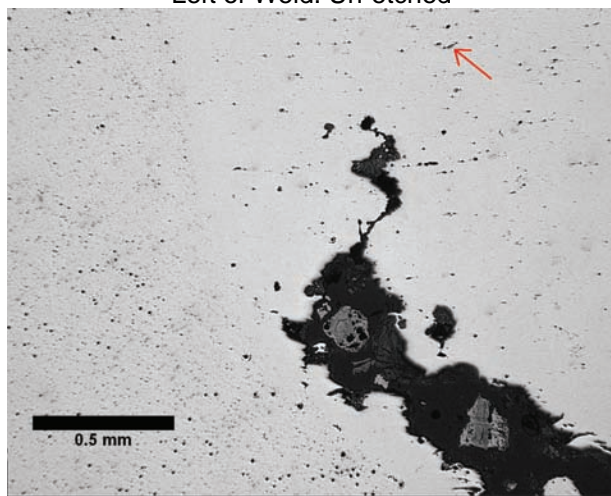

Right of Weld



Right of Weld. Etched

Damage Depth	
Left of Weld	Right of Weld
2.54	1.23

Figure 20.

BETA LAB NO. M10198, REV. 1 - Tesoro E6600 HEAT EXCHANGER "E". SUMMARY OF THE RESULTS	TESORO REFINING AND MARKETING COMPANY ANACORTES REFINERY 10200 W. MARCH POINT ROAD T91WA4428 ANACORTES, WA 98221	CUSTOMER P.O. No.: 4501667904
PART: 6600-E HEAT EXCHANGER "E", ALL PARTS DAMAGE DEPTH, AND PART 17 MOUNTS		DATE: 3/7/2011 PAGE 42 OF 70

**LABORATORY REPORT**

**LS3 WELD, SAMPLES 14-M3/15-M3**

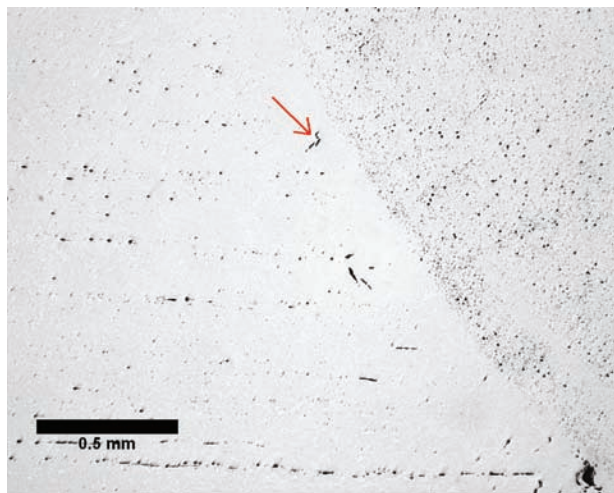
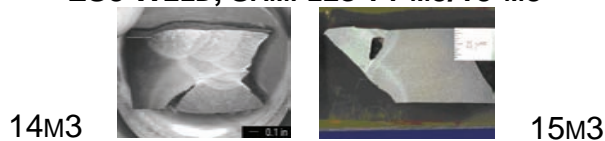

14-m3. Left of weld. Un-etched

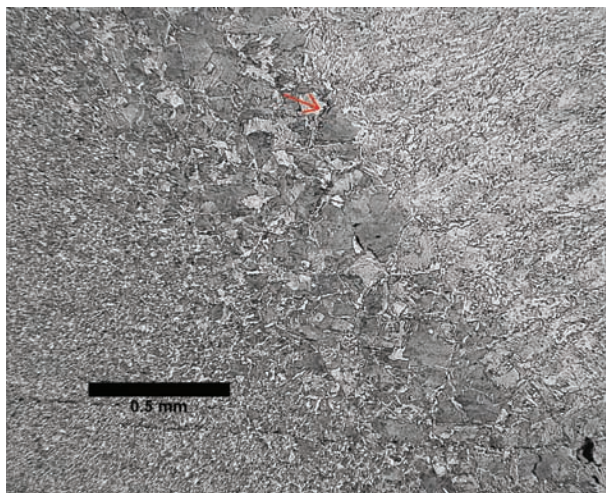

14-m3. Left of weld. Etched

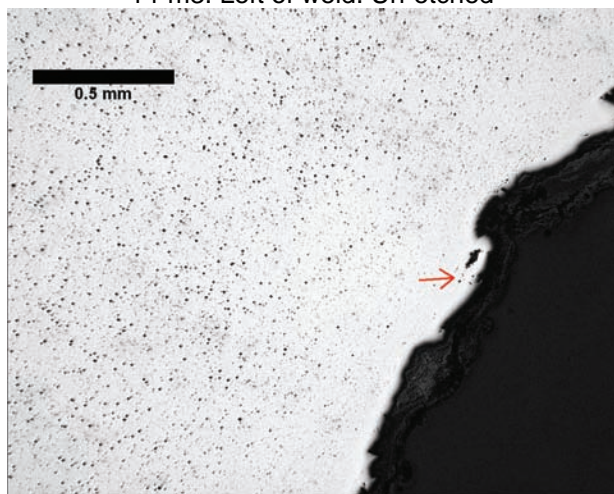

14-m3. Right of weld. Un-etched

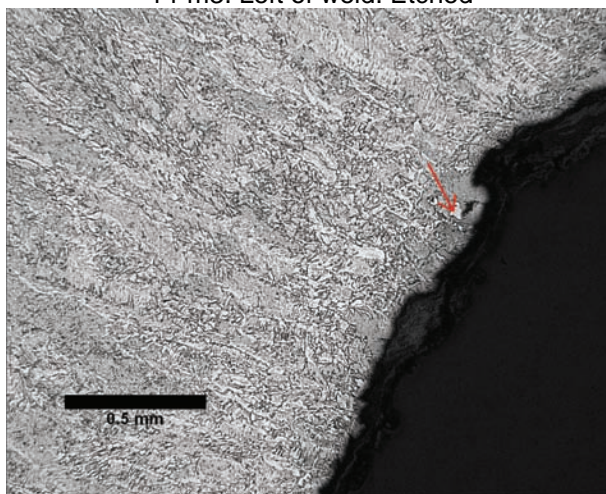

14-m3. Right of weld. Etched

Damage Depth, mm	
Left of Weld	Right of Weld
12.94	17.2

Figure 21. OD is on the top.

BETA LAB NO.M10198, REV. 1 - Tesoro E6600 HEAT EXCHANGER "E". SUMMARY OF THE RESULTS	TESORO REFINING AND MARKETING COMPANY ANACORTES REFINERY 10200 W. MARCH POINT ROAD T91WA4428 ANACORTES, WA 98221	CUSTOMER P.O. No.: 4501667904
PART: 6600-E HEAT EXCHANGER "E", ALL PARTS DAMAGE DEPTH, AND PART 17 MOUNTS	DATE: 3/7/2011 PAGE 43 OF 70	

**LABORATORY REPORT**

**LS3 WELD, SAMPLES 14-M4T/15-M4T**

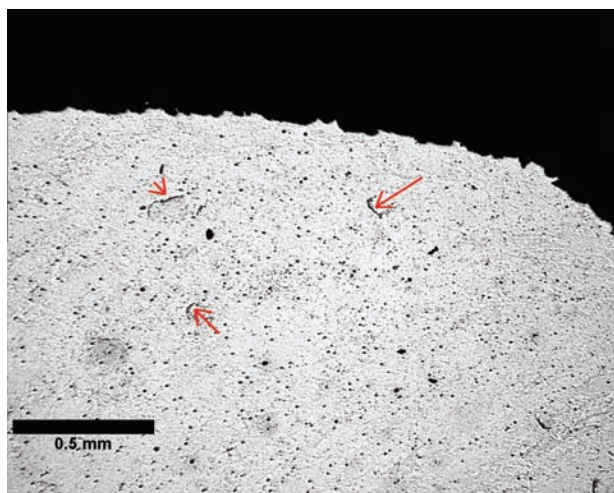
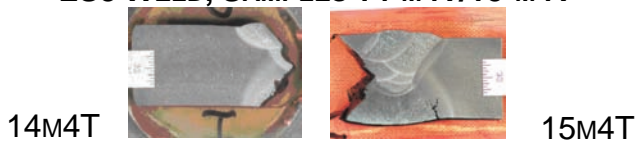

14-m4T. Left of the weld. Un-etched

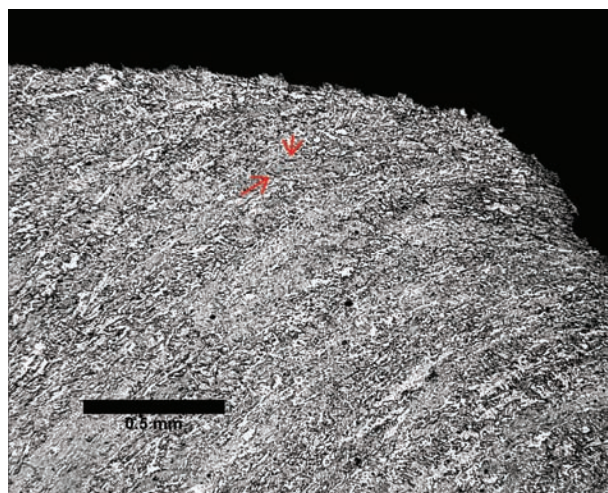

14-m4T. Left of the weld. Etched

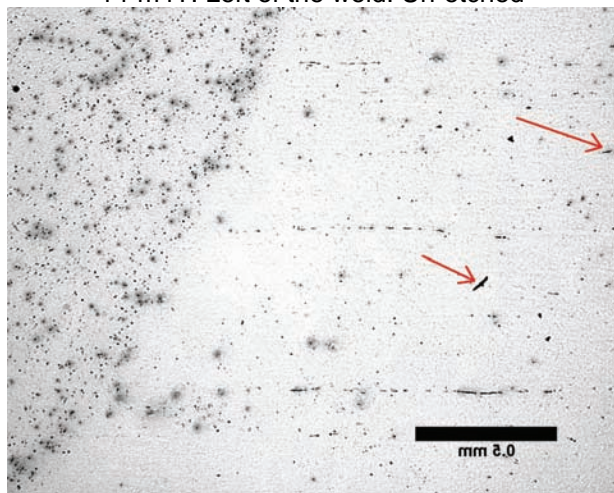

15-m4T. Right of the weld. Un-etched

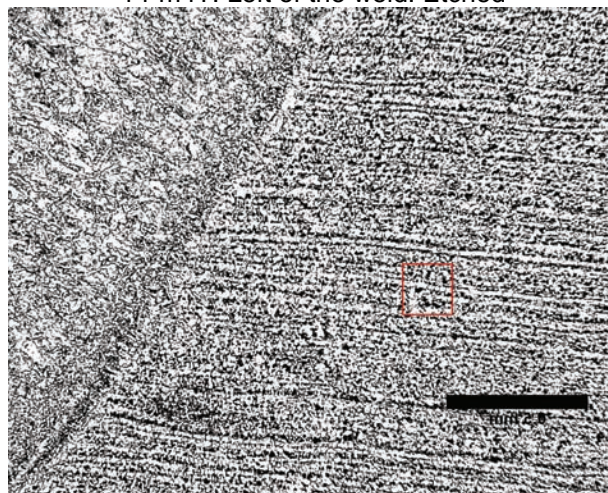

15-m4T. Right of the weld. Etched

Damage Depth, mm	
Left of Weld	Right of Weld
21.8	14.28

Figure 22. OD at the top.

BETA LAB NO.M10198, REV. 1 - Tesoro E6600 HEAT EXCHANGER "E". SUMMARY OF THE RESULTS	TESORO REFINING AND MARKETING COMPANY ANACORTES REFINERY 10200 W. MARCH POINT ROAD T91WA4428 ANACORTES, WA 98221	CUSTOMER P.O. No.: 4501667904
		DATE: 3/7/2011
PART: 6600-E HEAT EXCHANGER "E", ALL PARTS DAMAGE DEPTH, AND PART 17 MOUNTS		PAGE 44 OF 70

**LABORATORY REPORT**

**LS3 WELD, SAMPLES 14-T0/15-T0**

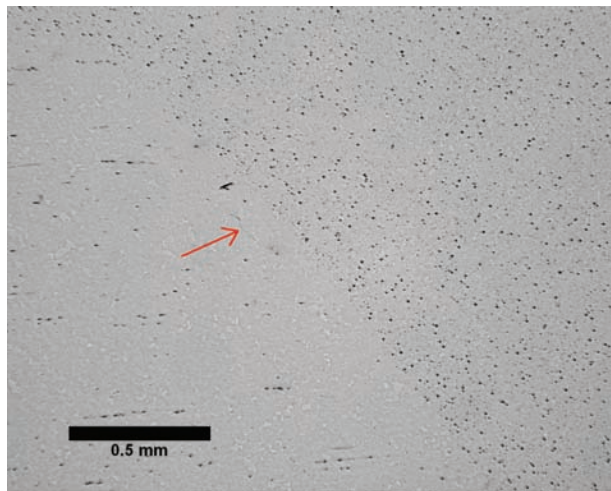
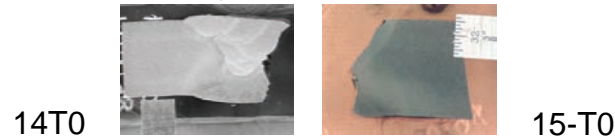

14-T0. Left of the weld. Un-etched

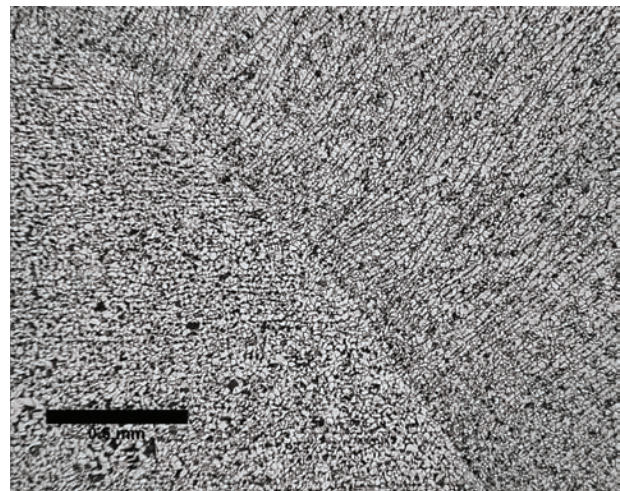

14-T0. Left of the weld. Etched

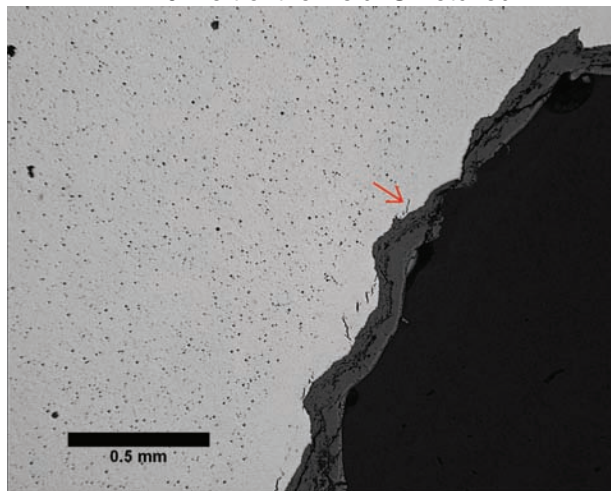

14-T0. Right of the weld. Un-etched

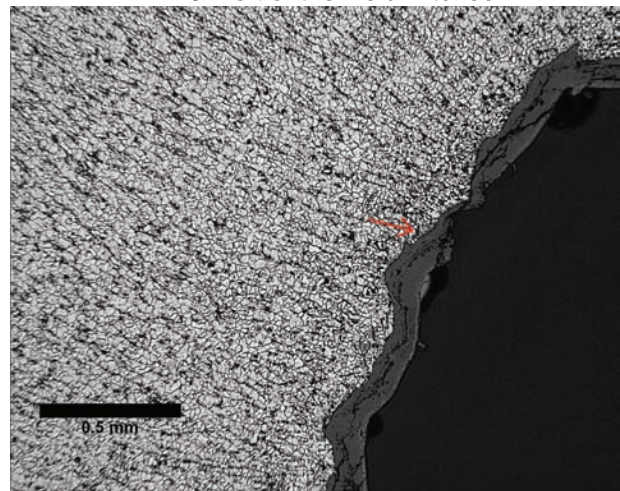

14-T0. Right of the weld. Etched

Damage Depth, mm	
Left of Weld	Right of Weld
20.91	21.8 (14-T0)

Figure 23. OD on top

BETA LAB NO.M10198, REV. 1 - Tesoro E6600 HEAT EXCHANGER "E". SUMMARY OF THE RESULTS  PART: 6600-E HEAT EXCHANGER "E", ALL PARTS DAMAGE DEPTH, AND PART 17 MOUNTS	TESORO REFINING AND MARKETING COMPANY ANACORTES REFINERY 10200 W. MARCH POINT ROAD T91WA4428 ANACORTES, WA 98221	CUSTOMER P.O. No.: 4501667904
		DATE: 3/7/2011
		PAGE 45 OF 70

**LABORATORY REPORT  
LS3 WELD, SAMPLES 14-T0/15-T0**

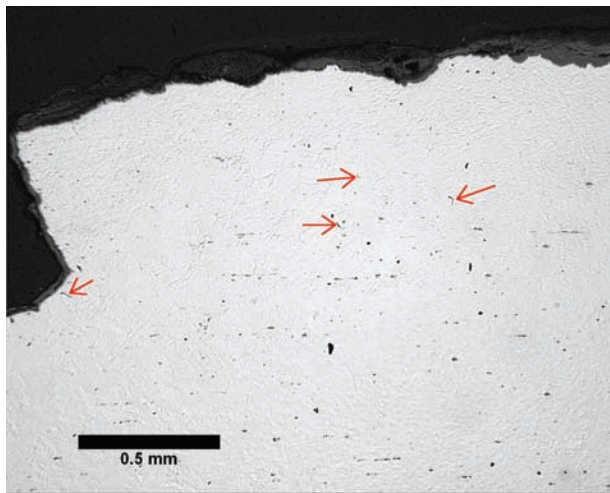
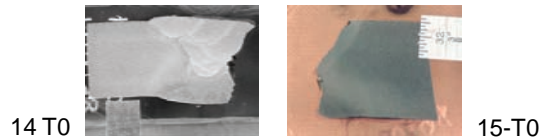

15-T0. Un-etched

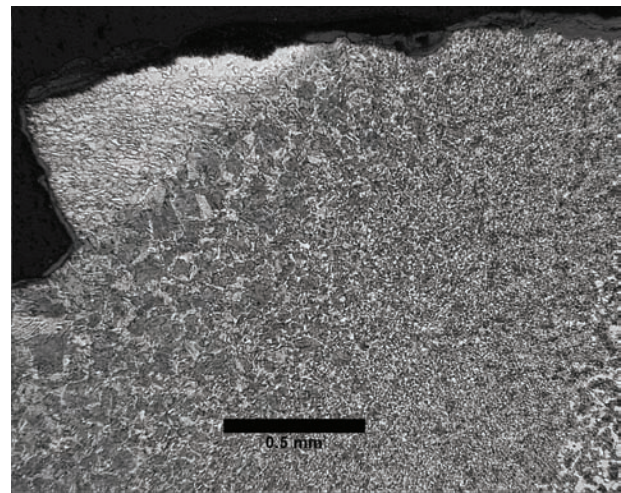

15-T0. Etched

Damage Depth, mm	
Left of Weld	Right of Weld
NA	21.8

Figure 24. OD is at top.

BETA LAB NO.M10198, REV. 1 - Tesoro E6600  
HEAT EXCHANGER "E". SUMMARY OF THE RESULTS  
PART: 6600-E HEAT EXCHANGER "E", ALL PARTS  
DAMAGE DEPTH, AND PART 17 MOUNTS

TESORO REFINING AND MARKETING COMPANY  
ANACORTES REFINERY  
10200 W. MARCH POINT ROAD T91WA4428  
ANACORTES, WA 98221

CUSTOMER P.O. No.: 4501667904

DATE: 3/7/2011

PAGE 46 OF 70

**LABORATORY REPORT**

**CS3 WELD, SAMPLE 14-M6**

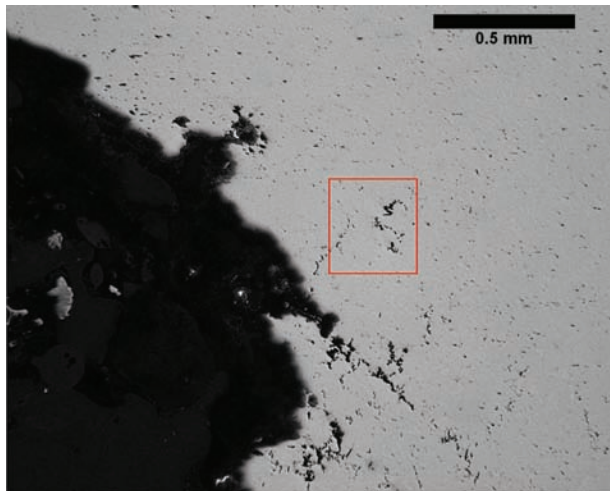
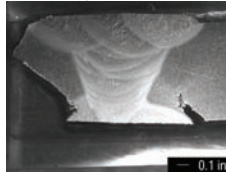

Left of the weld. Un-etched

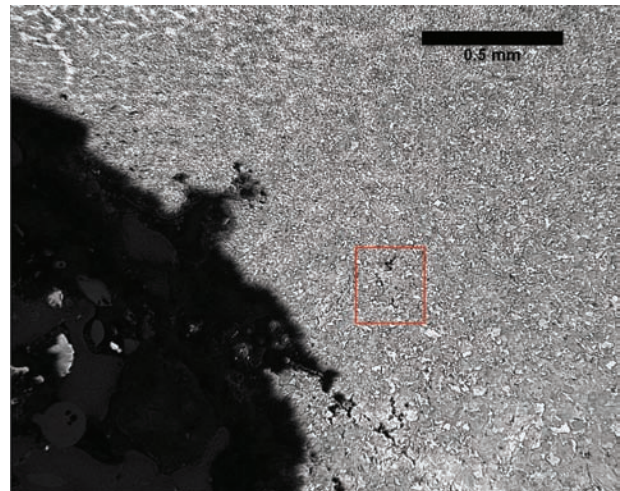

Left of the weld. Etched.

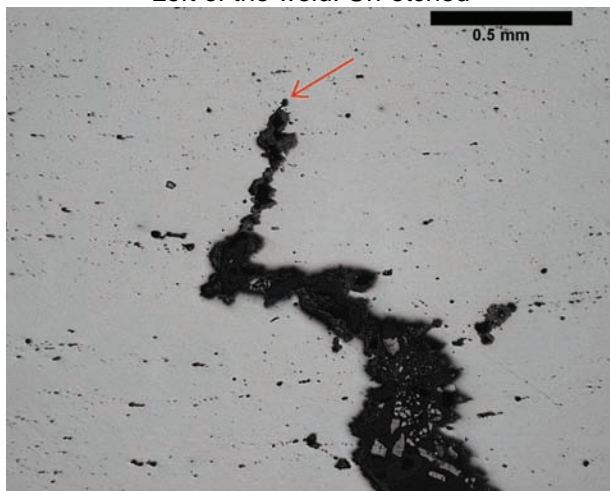

Right of the weld. Un-etched.

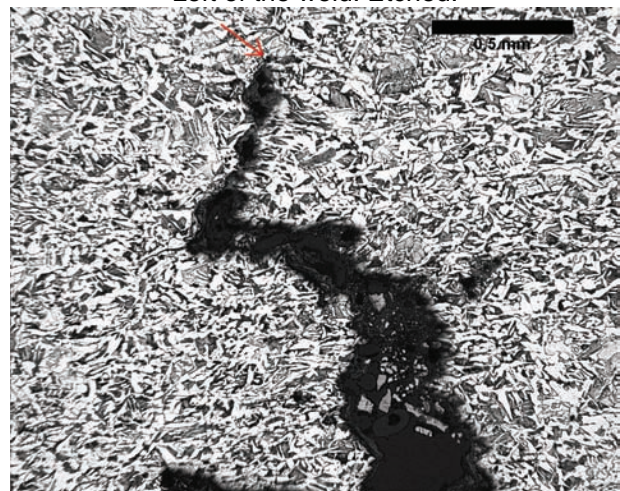

Right of the weld. Etched.

Damage Depth	
Left of Weld	Right of Weld
3.37	7.29

Figure 25. OD is at top.

BETA LAB NO.M10198, REV. 1 - Tesoro E6600 HEAT EXCHANGER "E". SUMMARY OF THE RESULTS  PART: 6600-E HEAT EXCHANGER "E", ALL PARTS DAMAGE DEPTH, AND PART 17 MOUNTS	TESORO REFINING AND MARKETING COMPANY ANACORTES REFINERY 10200 W. MARCH POINT ROAD T91WA4428 ANACORTES, WA 98221	CUSTOMER P.O. No.: 4501667904
		DATE: 3/7/2011
		PAGE 47 OF 70

**LABORATORY REPORT**

**PART 16-1. PARTLY LS2 AND PARTLY CS3 WELDS, SAMPLE T-2**

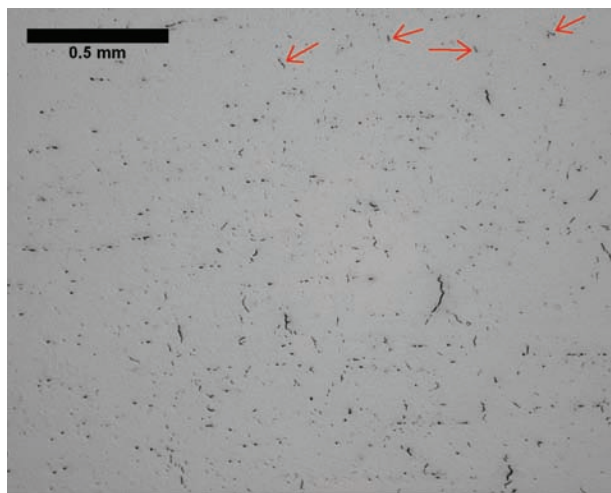
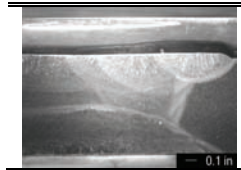

Right of both, LS2 and CS3 welds. Un-etched

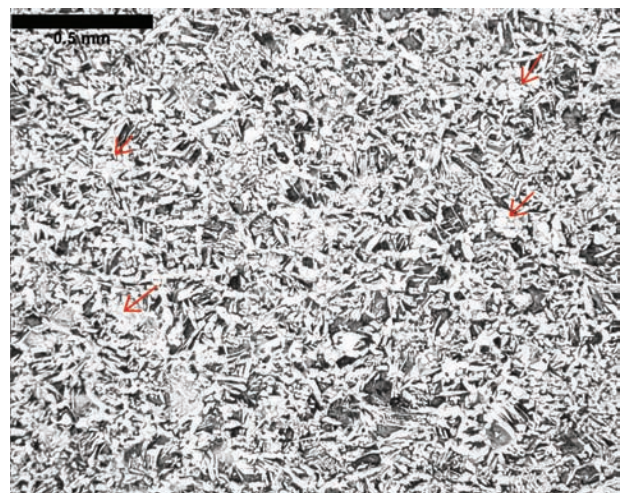

Right of both, LS2 and CS3 welds. Etched

**Damage Depth**

Left of Weld	Right of Welds
0 (Can 2)	5.66 (Can 3)

Figure 26. OD is at top.

BETA LAB NO.M10198, REV. 1 - Tesoro E6600 HEAT EXCHANGER "E". SUMMARY OF THE RESULTS	TESORO REFINING AND MARKETING COMPANY ANACORTES REFINERY 10200 W. MARCH POINT ROAD T91WA4428 ANACORTES, WA 98221	CUSTOMER P.O. No.: 4501667904
		DATE: 3/7/2011
PART: 6600-E HEAT EXCHANGER "E", ALL PARTS DAMAGE DEPTH, AND PART 17 MOUNTS		PAGE 48 OF 70

**LABORATORY REPORT  
PART 16-1. CS3 WELD, SAMPLE T-2C**

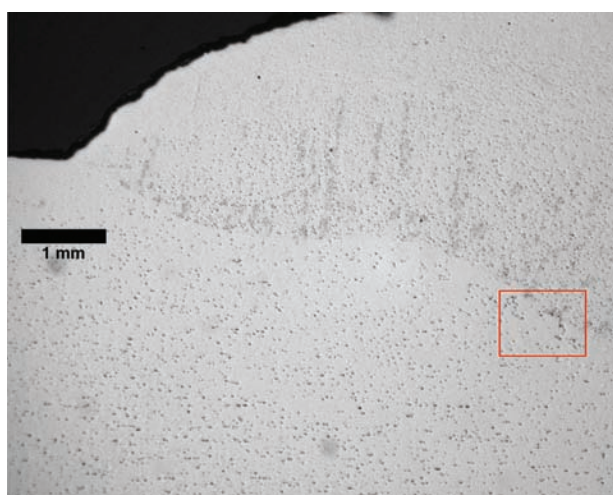
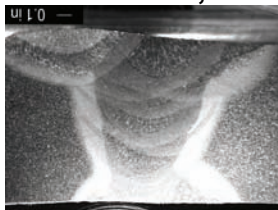

Area left of weld at cap. Un-etched

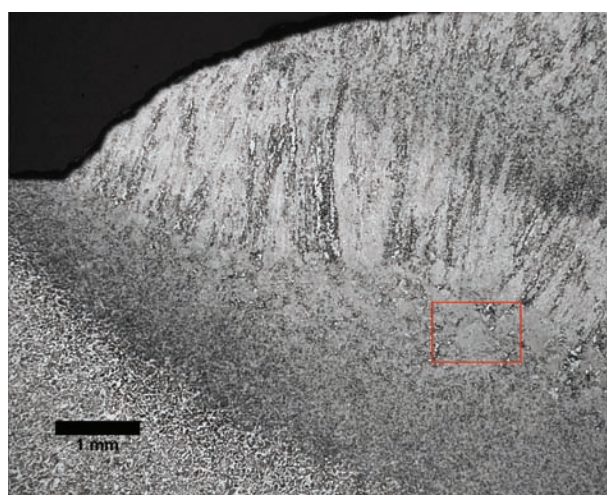

Area left of weld at cap. Etched

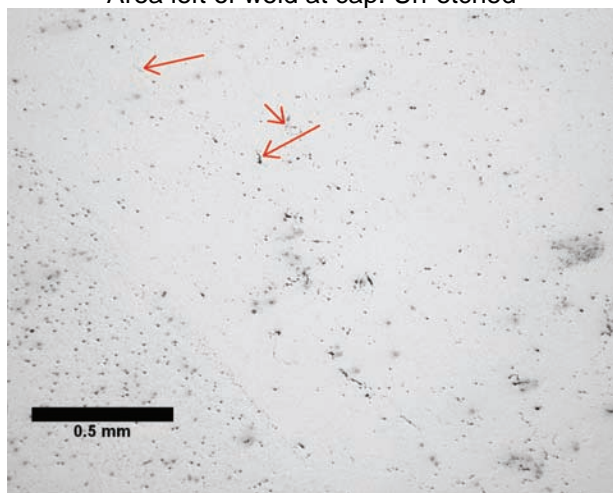

Area right of weld. Un-etched

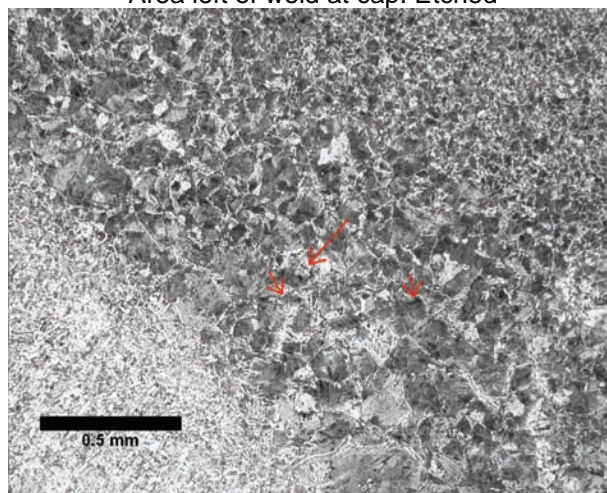

Area right of weld. Etched

Damage Depth	
Left of Weld	Right of Weld
19.9	0.344

Figure 27. OD is at top. See explanation of the reason to issue a Revision of the report at the page 1.



BETA LAB NO.M10198, REV. 1 - Tesoro E6600 HEAT EXCHANGER "E". SUMMARY OF THE RESULTS	TESORO REFINING AND MARKETING COMPANY ANACORTES REFINERY 10200 W. MARCH POINT ROAD T91WA4428 ANACORTES, WA 98221	CUSTOMER P.O. No.: 4501667904
PART: 6600-E HEAT EXCHANGER "E", ALL PARTS DAMAGE DEPTH, AND PART 17 MOUNTS		DATE: 3/7/2011
		PAGE 49 OF 70

**LABORATORY REPORT  
PART 16-1. LS2 WELD, SAMPLE T-2L**

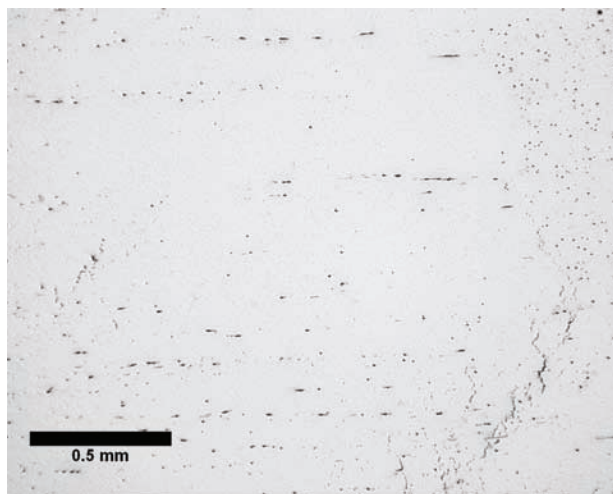
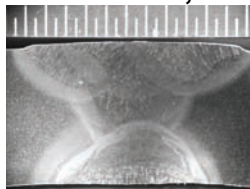

Left of weld. Un-etched

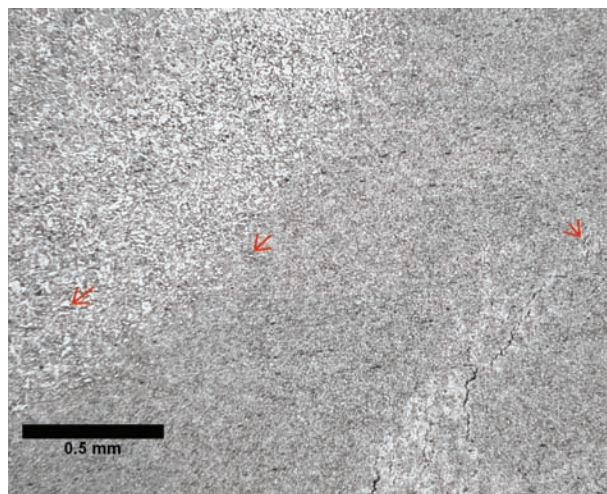

Left of weld. Etched

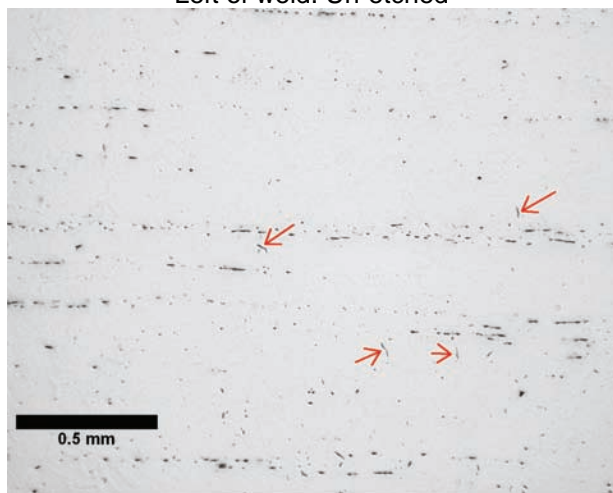

Right of weld. Un-etched



Right of weld. Etched

Damage Depth	
Left of Weld	Right of Weld
5.85	7.45

Figure 28. OD is on top.

BETA LAB NO.M10198, REV. 1 - Tesoro E6600 HEAT EXCHANGER "E". SUMMARY OF THE RESULTS	TESORO REFINING AND MARKETING COMPANY ANACORTES REFINERY 10200 W. MARCH POINT ROAD T91WA4428 ANACORTES, WA 98221	CUSTOMER P.O. No.: 4501667904
PART: 6600-E HEAT EXCHANGER "E", ALL PARTS DAMAGE DEPTH, AND PART 17 MOUNTS		DATE: 3/7/2011
PAGE 50 OF 70		

**LABORATORY REPORT  
PART 16-2. LS2 WELD, SAMPLE 22" FROM CS3**

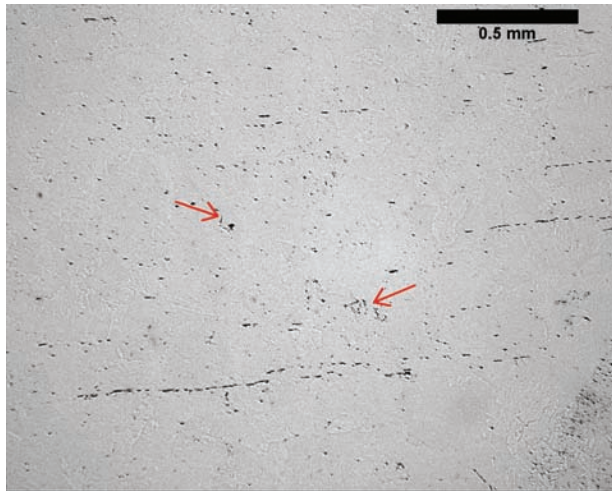
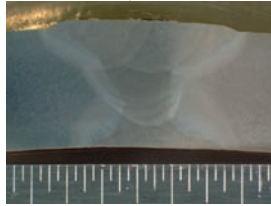

Left of the weld. Un-etched

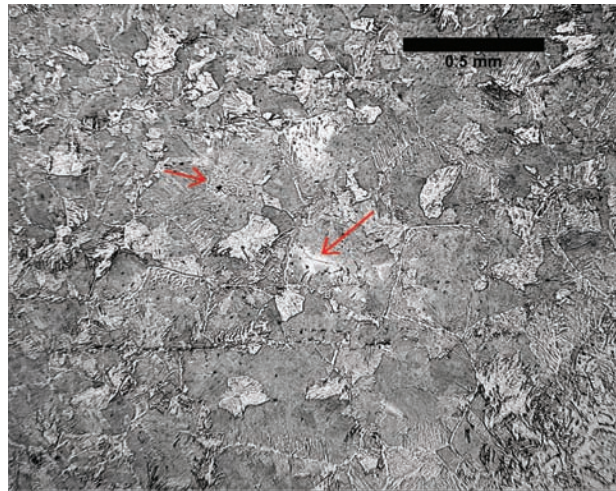

Left of the weld. Etched

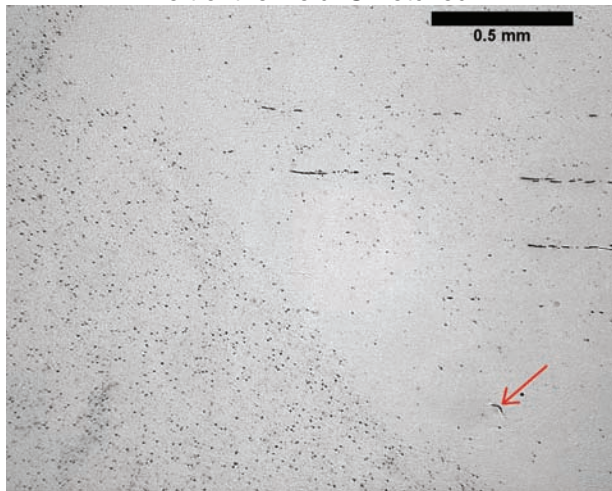

Right of the weld. Un-etched

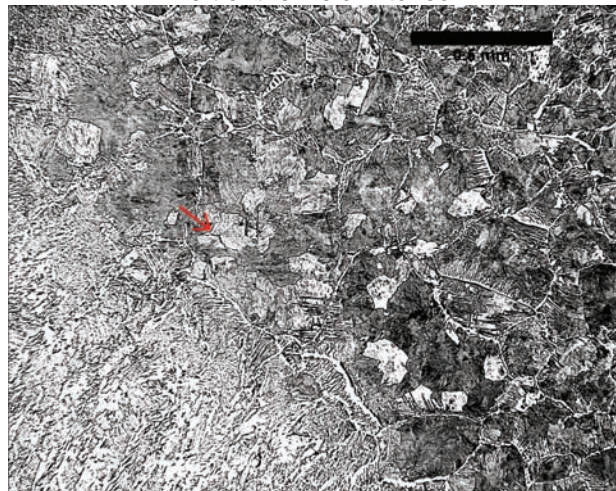

Right of the weld. Etched

Damage Depth, mm	
Left of Weld	Right of Weld
3.04	5.37

Figure 29. OD is on top.

BETA LAB NO.M10198, REV. 1 - Tesoro E6600  
HEAT EXCHANGER "E". SUMMARY OF THE RESULTS  
PART: 6600-E HEAT EXCHANGER "E", ALL PARTS  
DAMAGE DEPTH, AND PART 17 MOUNTS

TESORO REFINING AND MARKETING COMPANY  
ANACORTES REFINERY  
10200 W. MARCH POINT ROAD T91WA4428  
ANACORTES, WA 98221

CUSTOMER P.O. No.: 4501667904

DATE: 3/7/2011

PAGE 51 OF 70

**LABORATORY REPORT**

**PART 16-2. LS2 WELD, SAMPLE 36" FROM CS3**

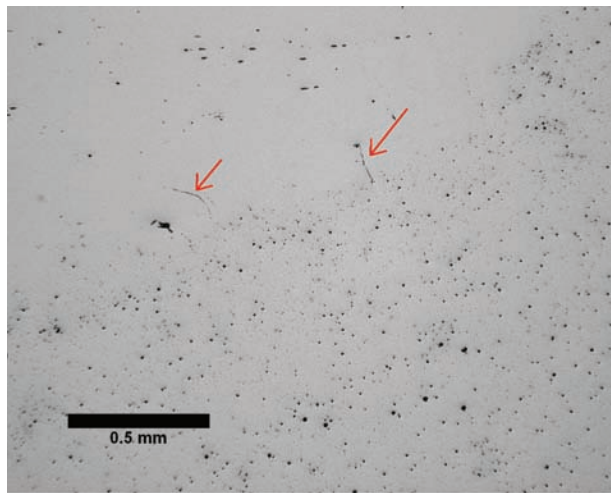
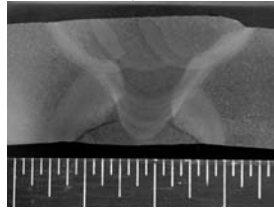

Left of the weld. Un-etched

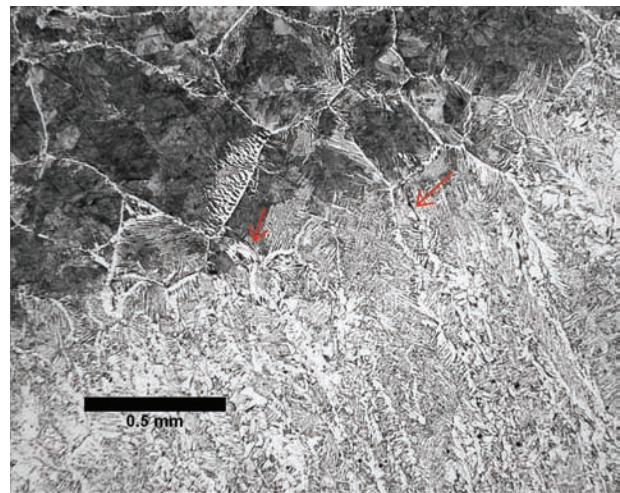

Left of the weld. Etched

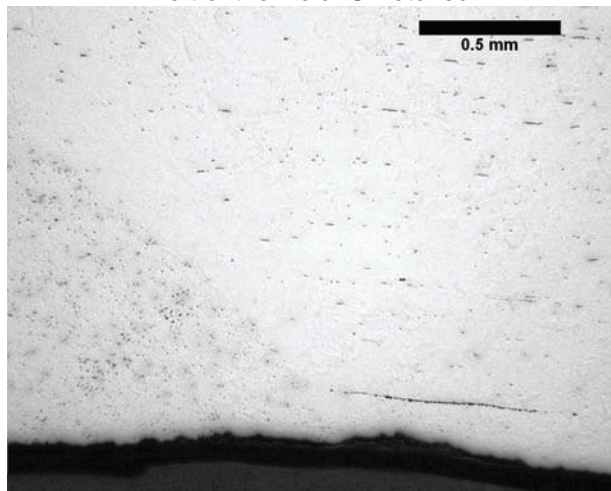

Right of the weld. Un-etched

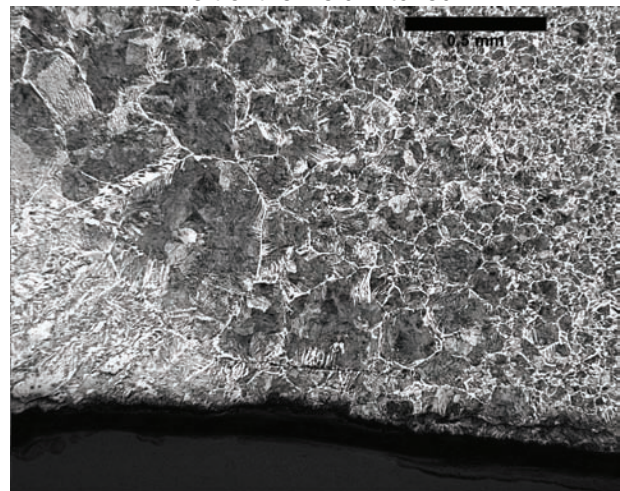

Right of the weld. Etched

Damage Depth, mm	
Left of Weld	Right of Weld
3.18	0

Figure 30. OD is on top.

BETA LAB NO.M10198, REV. 1 - Tesoro E6600 HEAT EXCHANGER "E". SUMMARY OF THE RESULTS	TESORO REFINING AND MARKETING COMPANY ANACORTES REFINERY 10200 W. MARCH POINT ROAD T91WA4428 ANACORTES, WA 98221	CUSTOMER P.O. No.: 4501667904
PART: 6600-E HEAT EXCHANGER "E", ALL PARTS DAMAGE DEPTH, AND PART 17 MOUNTS		DATE: 3/7/2011
PAGE 52 OF 70		

**LABORATORY REPORT  
PART 22, LS2-CS2-T, SAMPLE LS2-A**

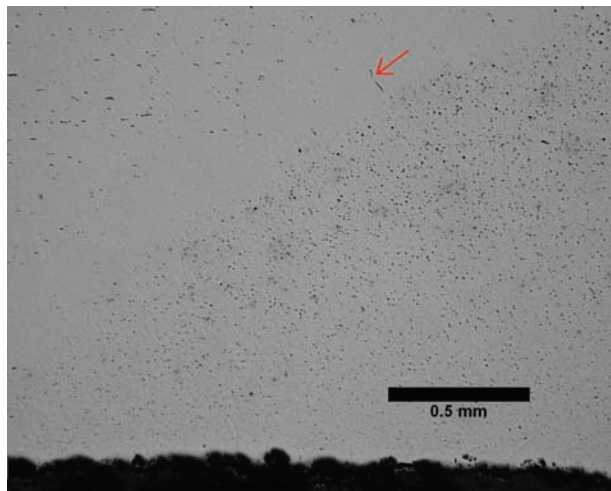
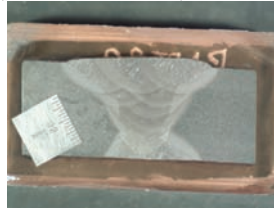

Left of the weld. Un-etched

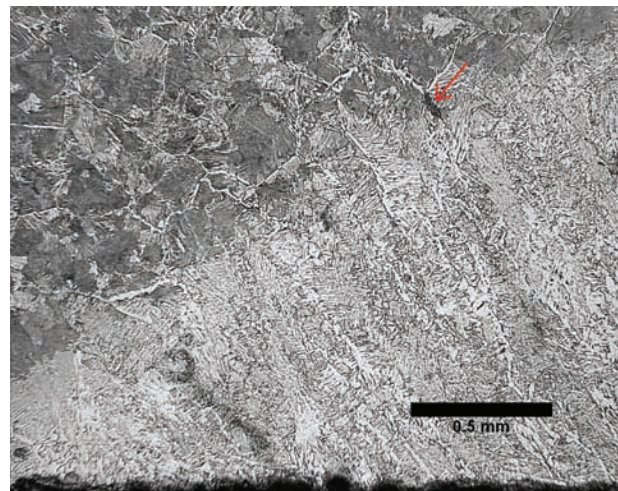

Left of the weld. Etched

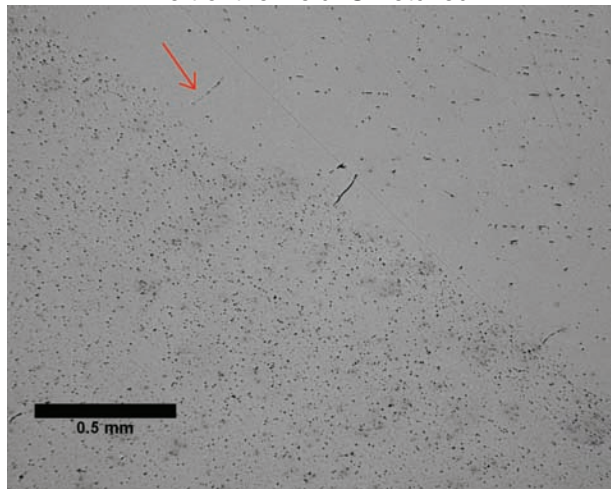

Right of the weld. Un-etched

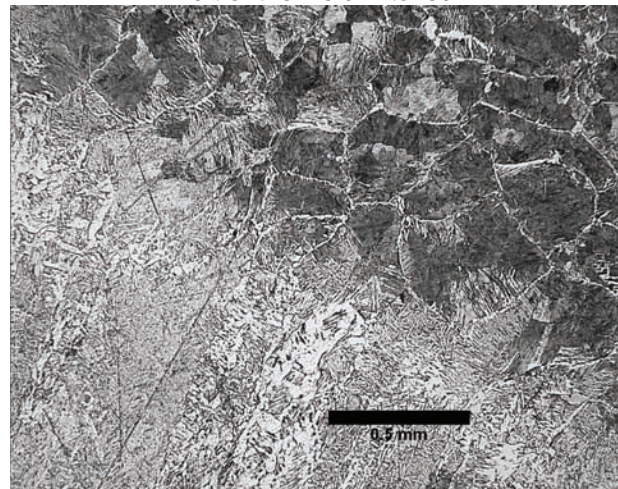

Right of the weld. Etched

Damage Depth, mm	
Left of Weld	Right of Weld
1.38	2.11

Figure 31. OD is on top.

BETA LAB NO.M10198, REV. 1 - Tesoro E6600  
HEAT EXCHANGER "E". SUMMARY OF THE RESULTS  
PART: 6600-E HEAT EXCHANGER "E", ALL PARTS  
DAMAGE DEPTH, AND PART 17 MOUNTS

TESORO REFINING AND MARKETING COMPANY  
ANACORTES REFINERY  
10200 W. MARCH POINT ROAD T91WA4428  
ANACORTES, WA 98221

CUSTOMER P.O. No.: 4501667904

DATE: 3/7/2011

PAGE 53 OF 70

**LABORATORY REPORT  
PART 22, LS2-CS2-T, SAMPLE CS2-A**

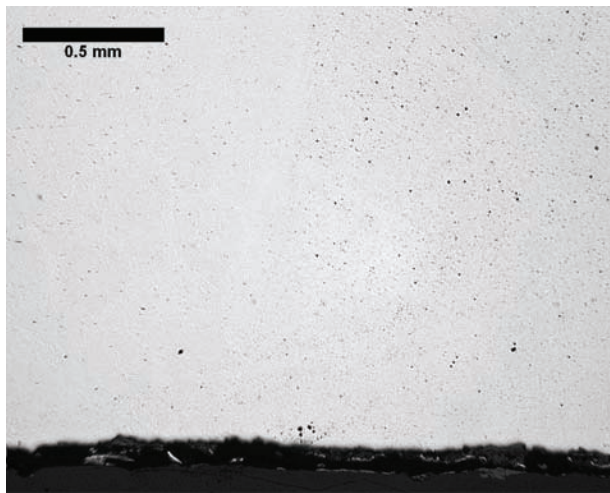

Left of the weld. Un-etched

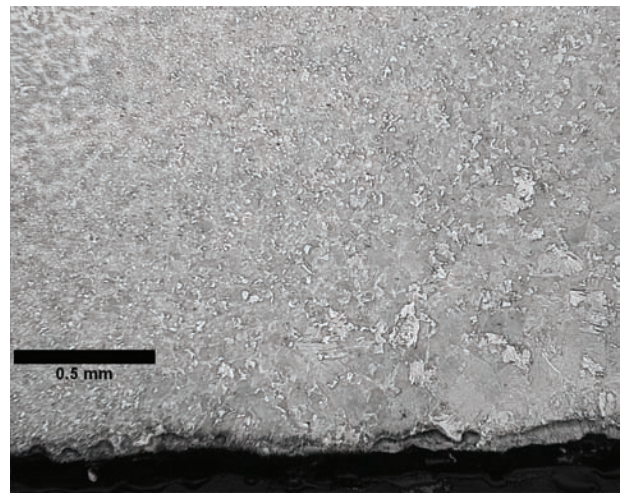

Left of the weld. Etched

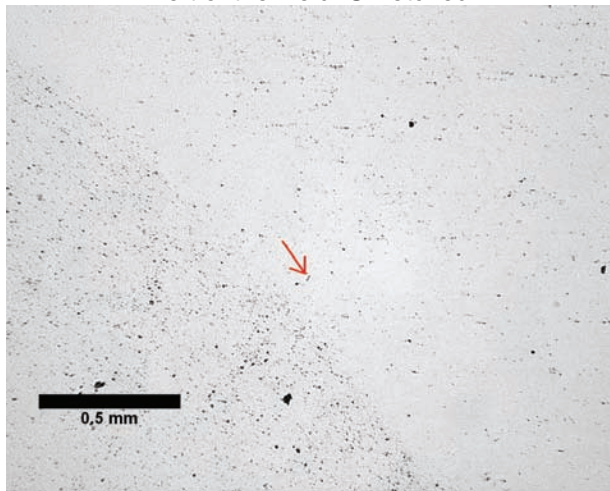

Right of the weld. Un-etched

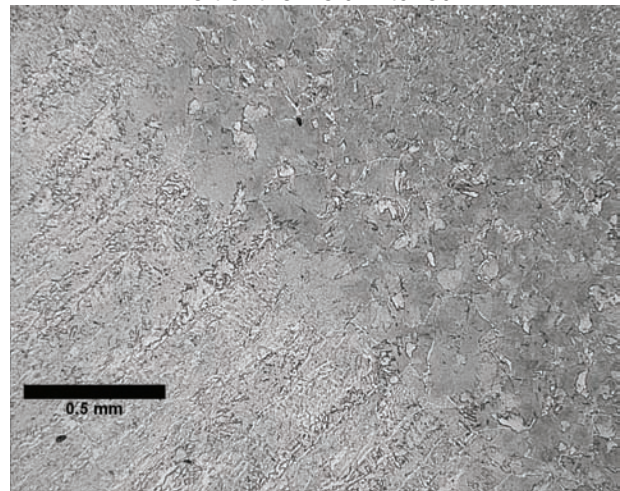

Right of the weld. Etched

Damage Depth	
Left of Weld	Right of Weld
0	4.05

Figure 32. OD is on top.

BETA LAB NO.M10198, REV. 1 - Tesoro E6600 HEAT EXCHANGER "E". SUMMARY OF THE RESULTS	TESORO REFINING AND MARKETING COMPANY ANACORTES REFINERY 10200 W. MARCH POINT ROAD T91WA4428 ANACORTES, WA 98221	CUSTOMER P.O. No.: 4501667904
PART: 6600-E HEAT EXCHANGER "E", ALL PARTS DAMAGE DEPTH, AND PART 17 MOUNTS		DATE: 3/7/2011
		PAGE 54 OF 70

**LABORATORY REPORT  
PART 17, Weld LS1, SAMPLE LS1**

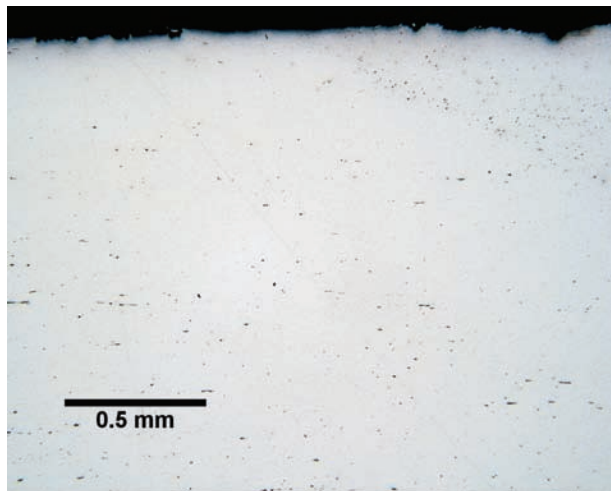
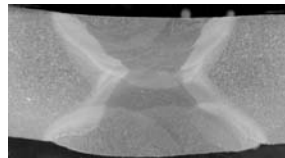

Left of the weld. Un-etched

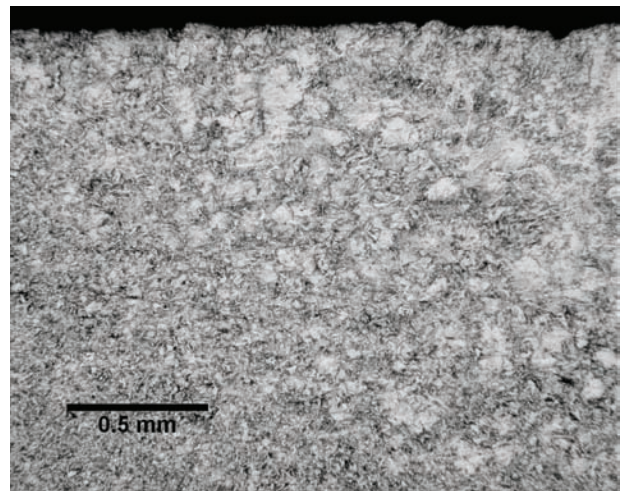

Same as at left. Etched

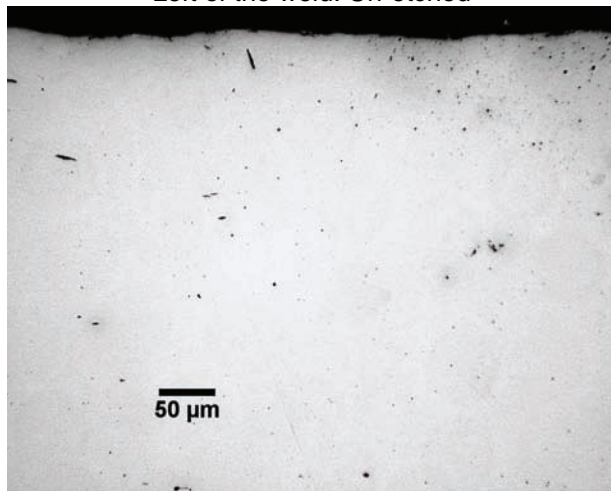

Same as above at higher magnification. Un-etched

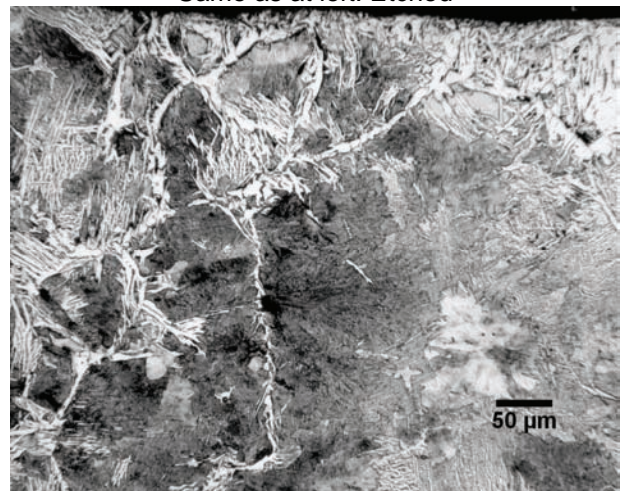

Same as at left. Etched

Damage Depth, mm	
Left of Weld	Right of Weld
0	0

Figure 33. ID is on top.

BETA LAB NO.M10198, REV. 1 - Tesoro E6600 HEAT EXCHANGER "E". SUMMARY OF THE RESULTS	TESORO REFINING AND MARKETING COMPANY ANACORTES REFINERY 10200 W. MARCH POINT ROAD T91WA4428 ANACORTES, WA 98221	CUSTOMER P.O. No.: 4501667904
PART: 6600-E HEAT EXCHANGER "E", ALL PARTS DAMAGE DEPTH, AND PART 17 MOUNTS		DATE: 3/7/2011
		PAGE 55 OF 70

**LABORATORY REPORT**  
**PART 17, Weld LS1, SAMPLE LS1**

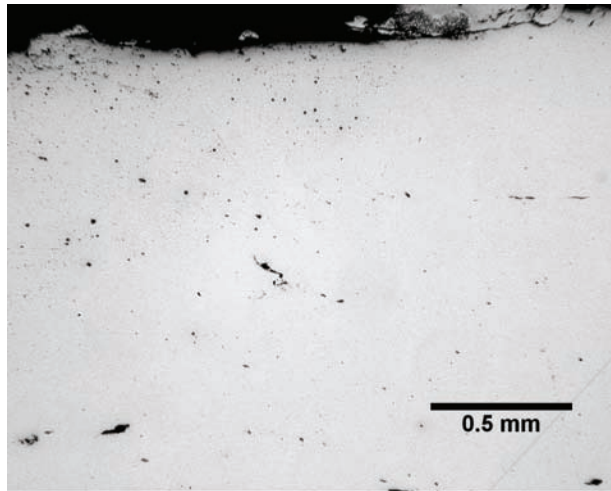
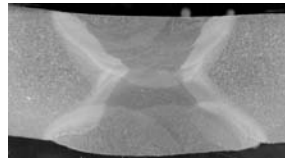

Right of the weld. Un-etched

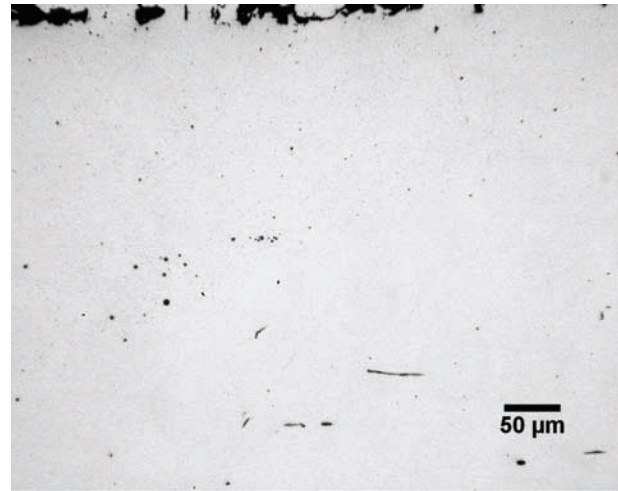

Right of the weld at higher magnification. Un-etched

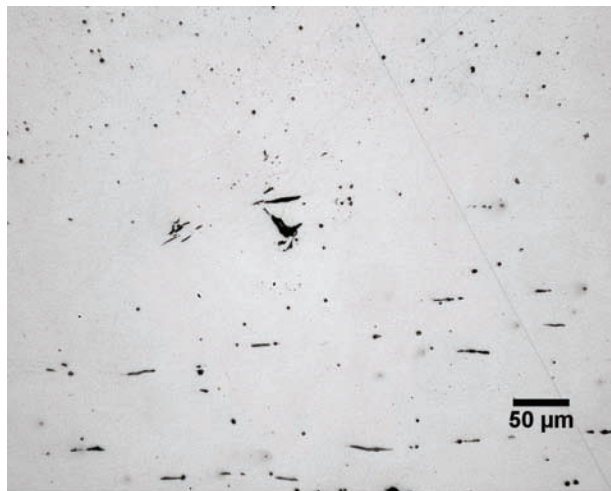

Right of the weld farther from ID. Un-etched

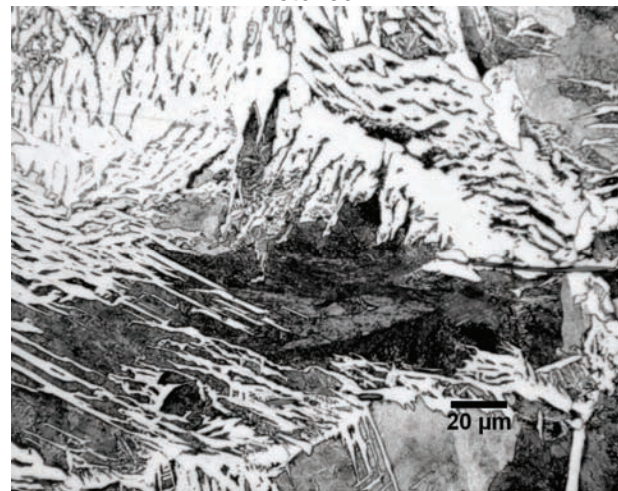

Right toe area at ID. Etched

Damage Depth, mm	
Left of Weld	Right of Weld
0	0

Figure 34. ID is on top.

BETA LAB NO.M10198, REV. 1 - Tesoro E6600 HEAT EXCHANGER "E". SUMMARY OF THE RESULTS	TESORO REFINING AND MARKETING COMPANY ANACORTES REFINERY 10200 W. MARCH POINT ROAD T91WA4428 ANACORTES, WA 98221	CUSTOMER P.O. No.: 4501667904
PART: 6600-E HEAT EXCHANGER "E", ALL PARTS DAMAGE DEPTH, AND PART 17 MOUNTS		DATE: 3/7/2011
		PAGE 56 OF 70

**LABORATORY REPORT**

**PART 17, Weld LS1, SAMPLE 17-LS1**

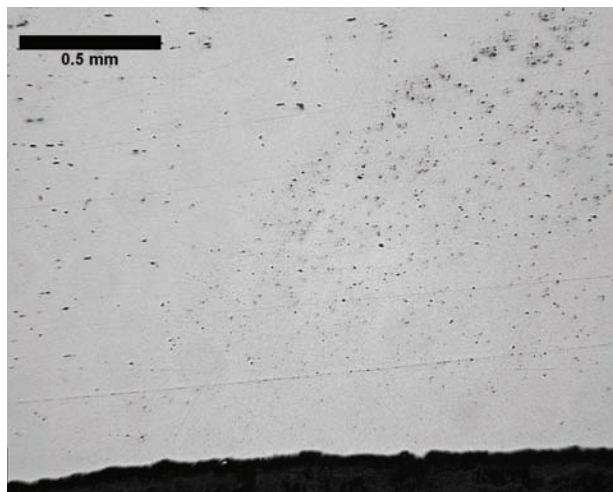
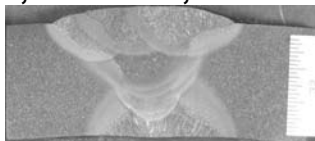

Left toe at the ID. Un-etched

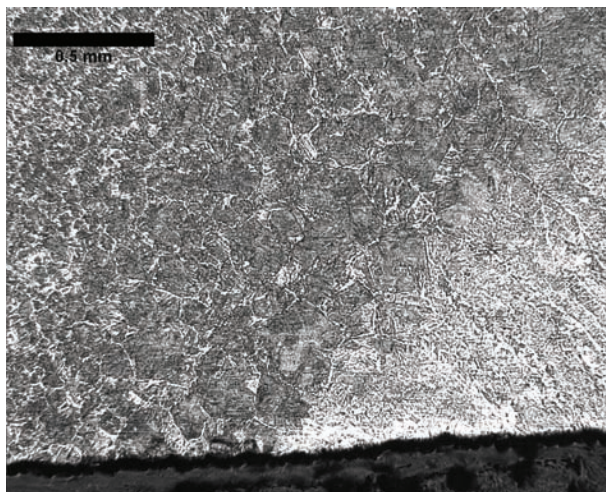

Same as on the left. Etched.

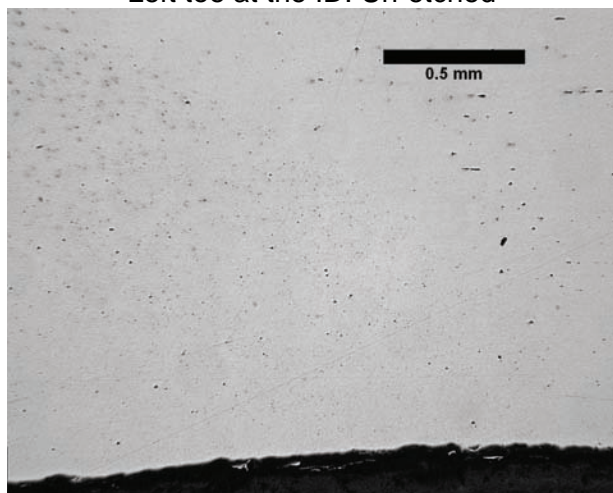

Right toe at the ID. Un-etched

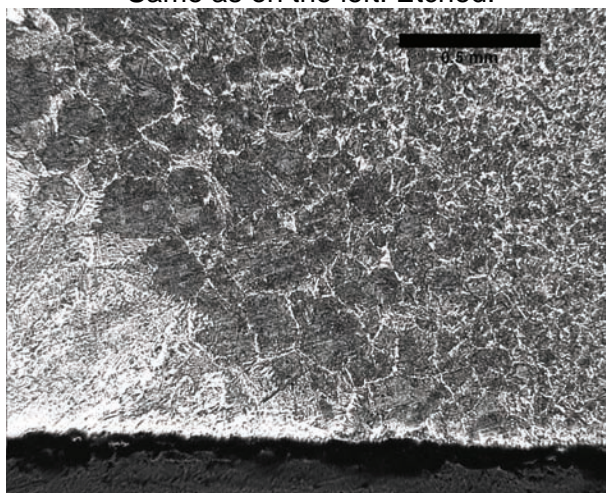

Same as on the left. Etched.

Damage Depth, mm	
Left of Weld	Right of Weld
0	0

Figure 35. OD is on top.



BETA LAB NO.M10198, REV. 1 - Tesoro E6600 HEAT EXCHANGER "E". SUMMARY OF THE RESULTS	TESORO REFINING AND MARKETING COMPANY ANACORTES REFINERY 10200 W. MARCH POINT ROAD T91WA4428 ANACORTES, WA 98221	CUSTOMER P.O. No.: 4501667904
PART: 6600-E HEAT EXCHANGER "E", ALL PARTS DAMAGE DEPTH, AND PART 17 MOUNTS		DATE: 3/7/2011
		PAGE 57 OF 70

## LABORATORY REPORT

### ATTACHMENT 1 TEST PROTOCOL AND ADDENDUM

### Tesoro Exchanger E Failure Examination Protocol

#### Part 1. Field Visual and Nondestructive Examination

*Part 1 of this protocol identifies visual and non-destructive testing that is approved to be conducted on the shell of exchanger 6600-E by a contractor acceptable to the parties to this agreement. Prior to performing any visual inspection or non-destructive testing, 3 business days notice must be provided to all parties to the agreement to allow the opportunity to observe. Parties to this agreement may elect not to perform aspects of the visual inspection or non-destructive testing described in this protocol. Should parties identify the need to conduct additional inspection or non-destructive testing not described in Part 1 of this protocol, 2 days notice must be provided to all parties to this agreement in order to register any objections.*

*Detailed visual inspection and testing will not be permitted until the equipment is placed in the secure evidence storage location.*

*All field visual and nondestructive tests shall be appropriately documented indicating examinations performed, scope of examinations, test equipment used in examinations, results of testing and the qualifications of the examiner as appropriate. All reports will be signed and dated by the examiner(s). Data reports shall be distributed within 48 hours of examinations by the third party conducting these examinations to all parties simultaneously. No party shall have the opportunity to review any data results in advance of the other parties. Any part requesting clarification or correction of anything in the report shall submit their request to all parties.*

*Data generated as a result of the execution of this protocol will be shared with all parties to the agreement simultaneously. Visual inspection reports, analysis or conclusion will not be shared.*

*Each party conducting field visual and nondestructive examination shall be assigned a unique set of alpha-numeric sets of markings. The format of the markings shall be AXXX, BXXX, CXXX, etc. The markings shall be applied to the external surfaces of the shell only and shall be permanent in nature (etch, stamp, etc.). Any markings shall be applied at least two (2) inches from any fracture surface. The markings shall be used for purposes described in Part 1 of this protocol and may also be used to identify locations of specific areas of interest determined by any examination conducted in Part 1. Each party using the markings shall supply a drawing identifying unique markings used and locations of these markings on the shell for information to all parties.*

#### Field Visual Examination

1. Photographically document the heat exchanger in the "as-found" condition before initiating the metallurgical analysis. Documentation should include the following:
  - Any reference points needed
  - Fracture area and surface
  - Seams

BETA LAB NO.M10198, REV. 1 - Tesoro E6600 HEAT EXCHANGER "E". SUMMARY OF THE RESULTS	TESORO REFINING AND MARKETING COMPANY ANACORTES REFINERY 10200 W. MARCH POINT ROAD T91WA4428 ANACORTES, WA 98221	CUSTOMER P.O. No.: 4501667904
PART: 6600-E HEAT EXCHANGER "E", ALL PARTS DAMAGE DEPTH, AND PART 17 MOUNTS		DATE: 3/7/2011
		PAGE 58 OF 70

## LABORATORY REPORT

### Tesoro Exchanger E Failure Examination Protocol

- Welds
  - Anomalies (dents, cracks, appurtenance)
  - Manufacturing flaws or defects
  - Pitting and/or evidence of corrosion on internal and external surfaces
2. Videotape the failed heat exchanger and surrounding heat exchangers and piping in the "as-found" condition. The videotape should similarly scan all items listed in (1) above. One scan should also offer a panoramic view of all affected surrounding equipment shot from a location immediately adjacent to the point of failure on the failed exchanger.
  3. Perform an initial field visual examination of the internal and external surfaces in the "as-found" condition, and document any anomalies that may be present such as the following:
    - Cracks
    - Crevices
    - Dents
    - Gouges
    - Manufacturing defects
    - Pitting and/or evidence of corrosion on internal and external surfaces
    - Presence of corrosion products and/or deposits
    - Examine the surface for evidence of cracks
    - Examine for evidence of arc burns, grinding around the surface area near the fracture

#### Additional considerations

- a. Fracture Surfaces: All fracture surfaces should be reviewed and photographed to check for:
  - thinning due to apparent corrosion
  - thinning due to necking
  - scaling (indicating an older crack)
  - beach or ratchet (chevron) marks pointing to the initiation site
  - proximity to welds and whether the crack propagates through weld metal, base metals or HAZs (Heat Affected Zones).
  - proximity to the end of the cladding
  - geometrical anomalies – e.g. gouges, sharp weld corners, mismatch, incomplete penetration of welds, etc
- b. Characterization of Internal Corrosion: Visible thinning or pitting on shell, tubes and baffles. Record description of all visible areas, with:
  - locations of corrosion on shell with length from outlet tubesheet and height from the bottom of the exchanger),
  - appearance of corrosion type on shell – thinning , pitting, etc
  - descriptions of scales
  - estimates of depths of observable corrosion and scales.

BETA LAB NO.M10198, REV. 1 - Tesoro E6600 HEAT EXCHANGER "E". SUMMARY OF THE RESULTS	TESORO REFINING AND MARKETING COMPANY ANACORTES REFINERY 10200 W. MARCH POINT ROAD T91WA4428 ANACORTES, WA 98221	CUSTOMER P.O. No.: 4501667904
PART: 6600-E HEAT EXCHANGER "E", ALL PARTS DAMAGE DEPTH, AND PART 17 MOUNTS		DATE: 3/7/2011
		PAGE 59 OF 70

## LABORATORY REPORT

### Tesoro Exchanger E Failure Examination Protocol

- c. Characterization of Fouling or Other Deposits:
  - Describe by color, volume, location, density, tenacity of adhering to surface, whether initiating on tubes or shell.
  - Use initial photos for comparison to see if fouling has been affected by atmospheric and weather exposure in the last few weeks.
  - Report any areas near fracture surface where the fouling seems to be removed due to the flow escaping from the fracture (to help define initial leak point).
- d. Characterization of Distortion – Possible Pre- or Post-Explosion:
  - Look for tube distortion such as pulling out of tubesheet or breaking behind tubesheet or baffles, or having contact with shell.
  - Look for bundle distortion which may be an affect of the explosion, and may indicate the initial leak point.
- e. Tracing Initial Leak Point by Surrounding Impingement or Damage:
  - Inspect adjacent equipment in the direction of the rupture and cracking, and report any signs of flow impingement, high temperature exposures, explosion pressure-wave, etc.

#### Field Visual and Nondestructive Examination

##### 1. Positive Materials Identification (PMI)

Perform PMI testing on all shell components and full penetration welds within two feet of the fracture surfaces using portable x-ray emission analyzers.

- Conduct all tests on external surfaces at least 6 inches away from all fracture surfaces.
- Conduct one test per weld located in the areas of interest on an external surface at least one foot away from all fracture surfaces.
- Unique numeric markings for identification purposes shall be made on the external surfaces of the shell where any PMI test was conducted.

##### 2. Deposit Collection

Deposits from the lower section of the bundle and representative deposits found adhered to the shell shall be collected and stored in clean glass covered jars for subsequent laboratory analysis. Unique numeric markings for identification purposes shall be made on the external surfaces of the shell and on the surface of the bundle where the deposits were collected. Photographs should be taken of locations where deposits are to be removed prior to removal.

BETA LAB NO.M10198, REV. 1 - Tesoro E6600 HEAT EXCHANGER "E". SUMMARY OF THE RESULTS	TESORO REFINING AND MARKETING COMPANY ANACORTES REFINERY 10200 W. MARCH POINT ROAD T91WA4428 ANACORTES, WA 98221	CUSTOMER P.O. No.: 4501667904
PART: 6600-E HEAT EXCHANGER "E", ALL PARTS DAMAGE DEPTH, AND PART 17 MOUNTS		DATE: 3/7/2011
		PAGE 60 OF 70

## LABORATORY REPORT

### Tesoro Exchanger E Failure Examination Protocol

Prior to collection of any samples, 3 business days notice shall be given to all parties to this agreement to provide the opportunity to observe sample collection. Analysis of collected samples must be approved by all parties to the agreement.

3. Field Crack Detection Ultrasonic Testing

Conduct ultrasonic examination adjacent to all fracture surfaces using techniques suitable for stress corrosion cracking or other potential service cracking mechanisms. Phased array is preferred for macro-cracking and AUBT is preferred for fissuring due to HTHA.

4. Physical Measurements

- Measure the wall thickness around fracture surfaces and any damaged areas. If corrosion is identified near or around the fracture surfaces, a "corrosion map" including reference points should be produced detailing the extent of the corrosion on the surfaces and the wall thicknesses in those areas. Measurements may be made using straight beam ultrasonic testing from the external surface.
- Record any markings detected on the inside or outside surfaces of the shell. Record name plate data.
- Measure rupture lengths tip-to-tip.
- Measure the shortest circumferential distance from each fracture origin to the nearest longitudinal weld and any attachment weld or structural discontinuity, such as nozzles, saddle supports, tubesheets, etc.
- Measure the axial distance from each fracture origin to the nearest circumferential weld, if any, and any attachment weld or structural discontinuity.
- Map wall thickness of each sample within 12 inches of each rupture origin using straight beam ultrasonic testing. Measurements will be taken on a 2-inch square grid pattern that is centered on the fracture origin.

5. Shell Course Match Marking

Suitable markings shall be made on external surfaces of shell sections on both sides of the separation at the circumferential weld to permit accurate recreation of the shell alignment of the two sections at the time of failure.

A minimum of 3 business days notice shall be given to all parties to this agreement to allow the opportunity to be present and determine the location of the shell course match markings. Mutual agreement of the parties present is required prior to making shell course markings.

### Part 2. Laboratory Examination

*The 6600-E exchanger will be submitted to a laboratory acceptable to all parties in as found condition for disassembly, further testing and evaluation. The parties will agree on a protocol*

BETA LAB NO.M10198, REV. 1 - Tesoro E6600 HEAT EXCHANGER "E". SUMMARY OF THE RESULTS	TESORO REFINING AND MARKETING COMPANY ANACORTES REFINERY 10200 W. MARCH POINT ROAD T91WA4428 ANACORTES, WA 98221	CUSTOMER P.O. No.: 4501667904
PART: 6600-E HEAT EXCHANGER "E", ALL PARTS DAMAGE DEPTH, AND PART 17 MOUNTS		DATE: 3/7/2011
		PAGE 61 OF 70

## LABORATORY REPORT

### Tesoro Exchanger E Failure Examination Protocol

*for disassembly and cutting prior to any such work. Some of the work below is redundant with the field inspections listed above and may be eliminated with concurrence from all parties if the field data is thought sufficient.*

*The laboratory will provide a schedule of activities and testing 3 business day prior to commencing any work to the parties to this agreement in order to receive the opportunity to be present and observe testing.*

**1. Material Preparation for Shipment and Receipt**

- All materials shall be photographed as found, once secured for shipping, and as received.
- The 6600-E exchanger will be submitted to the laboratory in as found condition for disassembly, further testing and evaluation. . Spray fracture surfaces with clear lacquer (Krylon or Rustoleum clear spray) dissolvable in acetone to protect fracture surfaces from corrosion. Fracture surfaces shall be protected from mechanical damage during transport (e.g. a split rubber hose pressed along the edge of the sample).
- The exchanger will be secured to a transport trailer, and protected by a hard cover (e.g. wood box or "conex" with the bottom removed) with a door secured by a tamperproof seal prior to shipment.
- An inspection of the tamperproof seal will be documented on the chain of custody prior to shipment. The chain of custody will be signed by the representative of each interested party indicating the exchanger is ready for shipment
- Shipping details will be provided to the lab of choice.
- A representative of the laboratory will be present take receipt of the exchanger, photograph the as received condition and document any apparent shipping damage.
- The exchanger and any samples collected will be stored in a secure indoor location.

**Laboratory NDE Examinations**

1. Take caliper readings for thickness of middle of plate and all edges and document. If there is pitting corrosion damage, pits within the area of interest will be counted and the pit length, width and depth will be recorded. Take macro hardness readings of each plate. If there is noticeable scale, take scale samples and preserve in clean glass jar.
2. Inspect the failed section for isolated cracks or colonies of cracks using nondestructive testing techniques. Carbon steel surfaces surrounding the rupture should be cleaned with an appropriate non-abrasive cleaner and subsequently inspected using a wet fluorescent magnetic particle inspection (WFMT) method. The circumferential weld should be examined by dye penetrant (PT) and WFMT (this weld was backcladded with austenitic material and there will be a carbon steel heat affected zone on one side and austenitic cladding on the other side of the weld).
3. Visually examine the fracture surfaces in detail to identify the characteristics of the fracture, the presence of any defect or anomaly, and the failure initiation point(s). Utilize a suitable

BETA LAB NO.M10198, REV. 1 - Tesoro E6600 HEAT EXCHANGER "E". SUMMARY OF THE RESULTS	TESORO REFINING AND MARKETING COMPANY ANACORTES REFINERY 10200 W. MARCH POINT ROAD T91WA4428 ANACORTES, WA 98221	CUSTOMER P.O. No.: 4501667904
PART: 6600-E HEAT EXCHANGER "E", ALL PARTS DAMAGE DEPTH, AND PART 17 MOUNTS		DATE: 3/7/2011
		PAGE 62 OF 70

## LABORATORY REPORT

### Tesoro Exchanger E Failure Examination Protocol

method to thoroughly document the fracture surface including dimensional documentation. Suitable methods to document the fracture surface include, but are not limited to, the following:

- Foil method
- Photographs of macroscopic examination

#### Marking and Sample Selection for Analysis

1. Examine each tagged sample for areas where sections will be removed for further detailed analysis. The laboratory metallurgist with concurrence of all parties should determine the areas to sample for all analyses. Include areas directly opposite of any fractured weld/area to get both sides of the fracture.
2. Mark all areas chosen for further examination and label ID and OD. Include specimen side to be exposed when mounted.
3. Document those areas with macrophotographs, showing areas to be removed, ID tag, and reference measurements.
4. Mark all remote areas to be sampled for general chemical analysis and mechanical tests, including base metal, welds, and Heat Affected Zones (HAZ).

#### Fractographic/Metallographic Examination

1. Saw cutout sections to be mounted or looked at with Macroscope / optical light stereoscope, maintaining tag traceability and side to be examined.
2. Examine specimens with Macroscope and take pictures. If sample fracture surface was corroded before spraying with clear lacquer, then cut in half and keep one half and then take other half and remove lacquer with acetone and clean surface with a cleaning solution such as Endox. Then, examine specimens with Macroscope and take pictures. Retain some of the fracture surface of interest and go to Step 3.
3. Examine un-mounted and unpolished fracture surfaces of interest in an SEM at 5, 50, 100, 500, 1000 and 5000X to look for possible / likely initiation sites and clearly describe the fracture surface morphology (intergranular, cleavage, microvoid coalescence). Any deposit areas should be analyzed with EDS analysis.
4. Cold mount sample pieces in areas of interest for metallography.
5. Etch control numbers on each mount corresponding to original tags.

BETA LAB NO.M10198, REV. 1 - Tesoro E6600 HEAT EXCHANGER "E". SUMMARY OF THE RESULTS	TESORO REFINING AND MARKETING COMPANY ANACORTES REFINERY 10200 W. MARCH POINT ROAD T91WA4428 ANACORTES, WA 98221	CUSTOMER P.O. No.: 4501667904
PART: 6600-E HEAT EXCHANGER "E", ALL PARTS DAMAGE DEPTH, AND PART 17 MOUNTS		DATE: 3/7/2011
		PAGE 63 OF 70

## LABORATORY REPORT

### Tesoro Exchanger E Failure Examination Protocol

6. Grind and polish the surface of each sample using a series of progressively finer grit papers and polishing wheels to obtain a surface suitable for examination under a metallurgical microscope with magnification at 50X, 100X, 200X, 500X, 1000X, and 1500X.
7. Examine each mount in the unetched condition under a Macroscope at 5 to 50X magnification.
8. Take photomicrographs and document any areas of interest. Areas of interest may include:
  - At or near the fracture origin
  - Fracture surfaces
  - Weld seams and HAZs
  - Anomalies
  - Areas with indications of defects or cracks identified through visual and/or non-destructive testing
  - Areas exhibiting "typical" microstructures of the base metal, weld metal, and heat-affected zone.
9. Examine each mount under a metallurgical microscope for a higher magnification view of any areas on the sample.
10. Photograph any areas of interest.
11. Surface etch each mount with a Nital 5% etch solution (for A515-70) and reexamine using both the macro and microscopes.
12. Mounts that contain alloys other than carbon steel may require different etch solutions or techniques.
13. Photograph and document all areas of interest.
14. Decide if any mounts are to be further examined using a Scanning Electron Microscope (SEM) either in the etched or unetched condition in the case of the mounts.
15. Photograph and document all areas of interest.
16. Perform EDS analysis of any scale or weld/base metal zone as required on the polished mount samples.
17. All weld joint cross section specimens should be given a series of microhardness tests starting in base metal and traveling through the weld HAZ and weld metal using a protocol to be provided by the lab. If there is a fracture surface in cross section in a mount, take a microhardness reading adjacent to the fracture surface. Then take microhardness on the mounted specimen that came from the other side of the particular fracture location and perform a microhardness adjacent to the fracture surface.

BETA LAB NO.M10198, REV. 1 - Tesoro E6600 HEAT EXCHANGER "E". SUMMARY OF THE RESULTS	TESORO REFINING AND MARKETING COMPANY ANACORTES REFINERY 10200 W. MARCH POINT ROAD T91WA4428 ANACORTES, WA 98221	CUSTOMER P.O. No.: 4501667904
PART: 6600-E HEAT EXCHANGER "E", ALL PARTS DAMAGE DEPTH, AND PART 17 MOUNTS		DATE: 3/7/2011
		PAGE 64 OF 70

## LABORATORY REPORT

### Tesoro Exchanger E Failure Examination Protocol

*During the course of examination metallographic samples should be examined to characterize and validate any issues specific to the failure such as:*

- *Material specification, grade, and heat treatment*
- *Weld seam in area of fracture*
- *Weld seam in un-affected area*
- *Degradation of microstructure from service conditions*
- *Corrosion*
- *Indications of outside force damage*
- *Differences in microstructure based on op. temperature (which varies along the length of the shell)*

#### Mechanical Properties

Testing should be performed to determine the mechanical properties of the heat exchanger and any appurtenances. Mechanical properties of test specimens should not be taken from areas of the heat exchanger that have been plastically deformed as a result of the failure but shall include tests from all components within 2 feet of the fracture surfaces. These mechanical tests should at least include the following:

- Tensile Testing
- Charpy V-notch Impact Testing
- Chemical Analysis

#### 1. Tensile Testing

Tensile test specimens should be prepared and tested in accordance with ASTM A370 (Mechanical Testing of Steel Products) for the shell base metal and weld seams to measure yield strength, ultimate tensile strength, and elongation. The shell base metal should, at a minimum be tested in the transverse direction, and weld seam specimens should be taken across the weld seam.

#### 2. Charpy V-notch Impact Testing

Charpy V-notch (CVN) specimens should be prepared and tested in accordance with ASTM E23 (Notched Bar Impact Testing of Metallic Materials) to determine the toughness characteristics of in the transverse direction. Transition curves shall be produced with three (3) specimens at each temperature. Results from CVN testing may be reported in some or all of the following forms depending on the testing results:

- Upper-Shelf Energy (in ft-lbs and SI units)
- Lower-Shelf Energy (in ft-lbs and SI)
- Ductile-to-Brittle Transition Temperature (50% in °F) determined from graphical representation of testing results
- Fracture Appearance Transition Temperature (in °F) corresponding to 50 % shear



BETA LAB NO.M10198, REV. 1 - Tesoro E6600 HEAT EXCHANGER "E". SUMMARY OF THE RESULTS	TESORO REFINING AND MARKETING COMPANY ANACORTES REFINERY 10200 W. MARCH POINT ROAD T91WA4428 ANACORTES, WA 98221	CUSTOMER P.O. No.: 4501667904
PART: 6600-E HEAT EXCHANGER "E", ALL PARTS DAMAGE DEPTH, AND PART 17 MOUNTS		DATE: 3/7/2011
		PAGE 65 OF 70

## LABORATORY REPORT

### Tesoro Exchanger E Failure Examination Protocol

- Lateral expansion (to measure notch toughness)  
 In some steels it may be difficult to measure percent shear because of "woody" fracture surfaces. In these cases it would be more appropriate to use lateral expansion and absorbed energy measurements to obtain a more accurate transition temperature.

Optional: If the charpy transition curves or fracture appearance displays any deviation from normal A515-70 material behavior, fracture mechanics testing should be performed to determine both static and dynamic fracture toughness. There are several standards and specimens that could be used and the appropriate test(s) should be agreed upon by all parties.

#### 3. Chemical Analysis

Chemistry samples representative of all components within two feet of the fracture surfaces shall be taken and analyzed in accordance with ASTM Specification A20 / A20M compared to ASME Section II material specifications. Perform Leco analysis for carbon. A determination of carbon equivalent for each test shall be made.

Energy dispersive spectroscopy (EDS) and either x-ray diffraction (XRD) or x-ray photoelectron spectroscopy (XPS) analyses may be used to determine elements and compounds present in surface deposits that were collected during the visual examination if considered germane to the investigation. Other suitable test methods may also be used.

#### High Temperature Hot Hydrogen Testing (OPTIONAL)

If the initial analysis appears to indicate HTHA, then have small specimens removed and analyzed per the Materials Property Council (MPC) Moly-Hy Joint Industry Program protocol at University of Tennessee. This protocol involves cryo-cracking (cryogenic induced fracture after immersing in liquid nitrogen) after machining a small notch in the material (probably close to fracture surface) and then examining the fracture surface with SEM at high magnification (5,000 – 15,000X). Another part of the protocol is to measure the non-diffusible hydrogen to infer the CH<sub>4</sub> content.

#### Laboratory Results Reporting/Sample Retention

1. All laboratory tests, including photographs or sketches, should be documented and summarized in a complete lab report. No analysis or conclusions shall be provided.
2. The Laboratory Report should be signed by a P.E from the laboratory.
3. An electronic version (e.g. pdf, jpg) report shall be distributed by the third party conducting these examinations to all parties simultaneously within 72 hours of completion. No party shall have the opportunity to review any results in advance of the other parties. Any part requesting clarification or correction of anything in the report shall submit their request to all parties

BETA LAB NO.M10198, REV. 1 - Tesoro E6600 HEAT EXCHANGER "E". SUMMARY OF THE RESULTS	TESORO REFINING AND MARKETING COMPANY ANACORTES REFINERY 10200 W. MARCH POINT ROAD T91WA4428 ANACORTES, WA 98221	CUSTOMER P.O. No.: 4501667904
PART: 6600-E HEAT EXCHANGER "E", ALL PARTS DAMAGE DEPTH, AND PART 17 MOUNTS		DATE: 3/7/2011
		PAGE 66 OF 70

**LABORATORY REPORT**

**Tesoro Exchanger E Failure Examination Protocol**

- 4. All samples that are cut, whether used or not and all samples analyzed shall be saved and stored in a manner that minimizes corrosion, by retaining in a container filled with desiccant or wrapping in plastic, etc.
- 5. The chain of custody form should be signed at all stages where the samples are handled within the lab or removed from the lab for any reason. Any markings/tags should be visible and retained.

**James Darnell**  
Vice President, Health and Safety  
Tesoro Companies

  
Signature 15 May 2010  
Date

**Robert Parker**  
Compliance Manager  
Division of Occupational Safety and Health

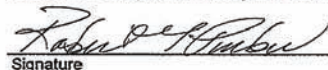
  
Signature 5-17-10  
Date

**Robert J. Hall**  
Investigator-in-Charge  
U.S. Chemical Safety Board

  
Signature 5-15-10  
Date

BETA LAB NO. M10198, REV. 1 - Tesoro E6600 HEAT EXCHANGER "E". SUMMARY OF THE RESULTS	TESORO REFINING AND MARKETING COMPANY ANACORTES REFINERY 10200 W. MARCH POINT ROAD T91WA4428 ANACORTES, WA 98221	CUSTOMER P.O. No.: 4501667904
PART: 6600-E HEAT EXCHANGER "E", ALL PARTS DAMAGE DEPTH, AND PART 17 MOUNTS		DATE: 3/7/2011
		PAGE 67 OF 70

**LABORATORY REPORT**

**Tesoro Exchanger E Failure Examination Protocol**  
**Addendum-1: Additional Work for Part 1 of Protocol**

**Part 1. Field Visual and Nondestructive Examination**

*All field visual and nondestructive tests shall be appropriately documented indicating examinations performed, scope of examinations, test equipment used in examinations, results of testing and the qualifications of the examiner as appropriate. All reports will be signed and dated by the examiner(s). Data reports shall be distributed by the third party conducting these examinations to all parties simultaneously. No party shall have the opportunity to review any data results in advance of the other parties. Any party requesting clarification or correction of anything in the report shall submit their request to all parties. Data generated as a result of the execution of this protocol will be shared with all parties to the agreement simultaneously. Visual inspection reports, analysis or conclusion will not be shared.*

**Field Visual and Nondestructive Examination**

**Current work in the section:**

- 3. Field Crack Detection Ultrasonic Testing

Conduct ultrasonic examination adjacent to all fracture surfaces using techniques suitable for stress corrosion cracking or other potential service cracking mechanisms. Phased array is preferred for macro-cracking and AUBT is preferred for fissuring due to HTHA.

**Additional work recommended for this section:**

Exchanger E: Perform phased array ultrasonic inspection on all full penetration welds located between the point of failure and the shell to tubesheet flange weld with the exception of nozzle welds. Data reports for the additional work will be provided to all parties simultaneously within 24 hours of completion of the inspection.

**James Darnell**  
**Vice President, Health and Safety**  
**Tesoro Companies**

  
 \_\_\_\_\_  
 Signature 20 MAY 2010  
 Date

**Robert Parker**  
**Compliance Manager**  
**Division of Occupational Safety and Health**

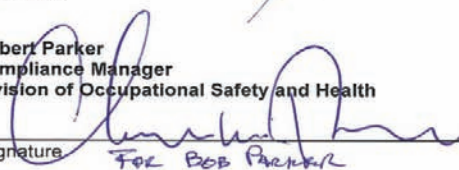
  
 \_\_\_\_\_  
 Signature 5-20-10  
 Date

**Robert J. Hall**  
**Investigator-in-Charge**  
**U.S. Chemical Safety Board**

  
 \_\_\_\_\_  
 Signature 5-20-10  
 Date

BETA LAB NO.M10198, REV. 1 - Tesoro E6600 HEAT EXCHANGER "E". SUMMARY OF THE RESULTS	TESORO REFINING AND MARKETING COMPANY ANACORTES REFINERY 10200 W. MARCH POINT ROAD T91WA4428 ANACORTES, WA 98221	CUSTOMER P.O. No.: 4501667904
PART: 6600-E HEAT EXCHANGER "E", ALL PARTS DAMAGE DEPTH, AND PART 17 MOUNTS		DATE: 3/7/2011
		PAGE 68 OF 70

## LABORATORY REPORT

### Tesoro Exchanger E Failure Examination Protocol Addendum – 3: Revisions/Lab Clarifications

This Addendum-3 to Exchanger E Failure Examination Protocol sets forth revisions to the original Inspection Protocol document.

1. The requirement to take caliper readings for thickness in the middle of the plate is deleted.
2. The requirement to take macro hardness readings on each plate will only apply to test plates supplied to the laboratory and not plates which remain attached to the heat exchanger.
3. The WFMT and PT shall be applied only to the ID surfaces in the vicinity of the fractures.
4. The fracture surfaces will be documented but the identification of the initiation point, the fracture mode and the interpretation of the fracture will be the responsibility of the signatory parties or their technical representatives.
5. Dimensional documentation of all fracture surfaces will be by inclusion of a scale in all photos.
6. The laboratory, acting as a referee laboratory, will be supplied the locations to take the test samples and the type of test and test parameters to be performed at each location on the test sample, i.e. magnification, hardness load/test method. The signatory parties or their technical representatives that are present in the laboratory at the time shall make those decisions and give that information directly to the laboratory. Comments from other technical experts will be considered and factored into the signatory parties or their technical representative's decisions but all decisions on protocol or samples shall remain as decisions of the signatory parties or their representatives.
7. The requirement for mounting samples on each side of any fractured weld /area will apply where convenient from the samples already cut out as of this date and will not apply to material still attached to the heat exchanger.
8. Since the fracture surfaces were not coated with any lacquer the requirement to cut each fracture sample in half, keeping one as is and cleaning only one half will not apply.
9. The acceptable cleaning methods for the SEM evaluation of the fracture surfaces are cathodic cleaning in mild alkaline or acid solution or alternatively Alconox and inhibited acid cycles. There is always a risk that extensive field corrosion has consumed the damage profile. One sample will be cleaned and evaluated in the SEM at any given time.
10. All magnifications listed in the test protocol are for equipment capability and the exact magnification and area of interest for all photomicrographs will be will be the responsibility of the signatory parties or their technical representatives present in the lab at the time.
11. A 2 % Nital etch solution is acceptable for use.
12. Because of all the deformation in the vicinity of the fractures the requirement to take the mechanical test specimens within 2 feet of the fractures is deleted.

BETA LAB NO.M10198, REV. 1 - Tesoro E6600 HEAT EXCHANGER "E". SUMMARY OF THE RESULTS  PART: 6600-E HEAT EXCHANGER "E", ALL PARTS DAMAGE DEPTH, AND PART 17 MOUNTS	TESORO REFINING AND MARKETING COMPANY ANACORTES REFINERY 10200 W. MARCH POINT ROAD T91WA4428 ANACORTES, WA 98221	CUSTOMER P.O. No.: 4501667904
		DATE: 3/7/2011
		PAGE 69 OF 70

**LABORATORY REPORT**

**Tesoro Exchanger E Failure Examination Protocol**  
**Addendum – 3: Revisions/Lab Clarifications**

13. The tensile and impact testing in the transverse direction is interpreted as transverse to the original plate rolling direction.

14. The requirement to simultaneously distribute the report within 72 hours of completion is deleted and the parties agree to a level 2 report, which contains descriptive text and captioned photos with the resultant assembly time being a function of the amount of data obtained but is typically 2-3 weeks. Any signatory party, its representative, or other party permitted to witness the laboratory testing may have the opportunity to see the data so long as there is no disruption to lab work but no one can have or make any copies of the laboratory work product prior to the Laboratory issuing the test report to the signatory parties.

**James Darnell**  
**Vice President, Health and Safety**  
**Tesoro Companies**

 \_\_\_\_\_ 7-6-10  
 Signature Date

**Robert Parker**  
**Compliance Manager**  
**Division of Occupational Safety and Health**

 \_\_\_\_\_ 7-6-10  
 Signature Date

**Robert J. Hall**  
**Investigator-in-Charge**  
**U.S. Chemical Safety Board**

 \_\_\_\_\_ 7-6-10  
 Signature Date

BETA LAB NO.M10198, REV. 1 - Tesoro E6600 HEAT EXCHANGER "E". SUMMARY OF THE RESULTS  PART: 6600-E HEAT EXCHANGER "E", ALL PARTS DAMAGE DEPTH, AND PART 17 MOUNTS	TESORO REFINING AND MARKETING COMPANY ANACORTES REFINERY 10200 W. MARCH POINT ROAD T91WA4428 ANACORTES, WA 98221	CUSTOMER P.O. No.: 4501667904
		DATE: 3/7/2011
		PAGE 70 OF 70

## LABORATORY REPORT

### Attachment2

#### TEST EQUIPMENT and PROCEDURES

TEST	INSTRUMENT & MODEL	CALIBRATION DUE DATE	BETA No.	LSS PROCEDURE	
				NUMBER & TITLE	REV No.
Failure Analysis	N/A	N/A	N/A	B0069 Failure Analysis	0
Chemical Analysis	Thermo ARL 3460 Optical Emission Spectrometer	Performance check prior to use	BETA 665	B0068 ARL 3460 Optical Emission Spectrometer Analysis	2
SEM/EDS	Amray Scanning Electron Microscope, Model: 1830T4, S/N: 18321002, with IXRF Energy Dispersive X-ray Spectrometer	*	BETA 386 BETA 755	B0064	*
SEM/EDS	Camscan Scanning Electron Microscope, Model: MV2300U, S/N: US0187039/VG0540181U with IXRF Energy Dispersive X-ray Spectrometer and x-ray Optics/AAT Detector	*	BETA 602 BETA 756	B0047	8
Rockwell Hardness	Wilson Rockwell 524T Hardness Tester, Model 83259910	Performance check prior to use	BETA 400	D0027 Wilson Rockwell Model 524T Hardness Tester	5
Rockwell Hardness	NewAge NI300-C Hardness Tester, Model 8150 S/N 951480	Performance check prior to use	BETA 897	D0052	*
Knoop/Vickers Hardness	Buehler Micromet II Digital Microhardness Tester, Model B-D58222	Performance check prior to use	BETA 401	D0028	*
Knoop/Vickers Hardness by Image Analysis	Buehler Micromet II Digital Microhardness Tester, Model B-D58222 with Buehler OmniMet Analysis System Program Version 9.0 Rev 3	Performance check prior to use	BETA 401 BETA 977	D0028	*
Field Hardness	Proceq Equotip Hardness Tester, Model 25-819	Performance check prior to use	BETA 428	D0016	*
Knoop/Vickers, Semi-Macro Vickers Hardness	Instron Tukon 2100B Hardness Tester, Model T2100BR1942	Performance check prior to use	BETA 2006	D0068 Instron Tukon 2100B Hardness Tester	0
Reagent Preparation^	N/A	N/A	N/A	C0005 Metallurgical Reagents ▲	7
Linear Measurements by Optical Methods	LECO PMG-3 Inverted Metallograph with Buehler OmniMet Analysis System Program Version 9.0 Rev 3	6/1/2011	BETA 419 BETA 977	D0065 Linear Measurement Using The Buhler Omnimet Imageing System	0
Average Grain Size	LECO PMG-3 Inverted Metallograph with Buehler OmniMet Analysis System Program Version 9.0 Rev 3	*	BETA 419 BETA 977	D0066	*
Dimensional	Starrett Micrometer Number 222	*	BETA DLC-C-094	NA	NA
Dimensional	Starrett Vernier S/N 120 A	*	BETA 2005	NA	NA
Dimensional	Mitutoyo Digital Micrometer 342-361	*	BETA 884	NA	NA
Mass	Mettler AE-100 S/N C-31383	*	BETA 113	NA	NA
Mass	Sartorius LP-6200S	*	MLL 0009	NA	NA

\*Denotes procedures or instruments not used in this report

▲ Etchant 5-1, 2% Nital