

BETA LAB NO.M10329-B, TESORO EXCHANGER E6600-B EXAMINATION DATA	TESORO REFINING AND MARKETING COMPANY ANACORTES REFINERY 10200 W. MARCH POINT ROAD T91WA4428 ANACORTES, WA 98221	CUSTOMER P.O. NO.: 4501667904, CHANGE ORDER #1
PARTS: E6600B HEAT EXCHANGER, PARTS 1B, 4B, AND 5B		DATE: MARCH 8, 2011
PAGE 1 OF 52		

LABORATORY REPORT

CONTACT:	JIM MCVAY
ISSUED BY:	MARK BRIDAVSKY
TELEPHONE EXTENSION:	440-604-9862
MAIL STOP:	A- BETA
REVIEWED BY :	JEFF BLOUGH

REPORT ISSUED TO:

Jim McVay	Robert J. Hall	Robert Parker
-----------	----------------	---------------

SAMPLE DESCRIPTION: A heat exchanger E6600-“B” was removed from operation at the Tesoro after undisclosed duration in service. The Exchanger B Shell Examination Protocol (Protocol) and Addendum 1 were developed and signed by Tesoro Companies, Division of Occupational Safety and Health, and U.S. Chemical Safety Board. The mentioned above Protocol and Addendum 1 are located in the Appendix 1 at the end of this Report. FirstEnergy BETA Laboratory was selected as the data collecting laboratory to perform the testing required by the Protocol. The BETA Laboratory, as a data collecting (referee) laboratory, acts under the same rules as in the previous job on the exchanger E6600E, which are as follows:

“The laboratory, acting as a referee laboratory, will be supplied the locations to take the test samples and the type of test and test parameters to be performed at each location on the test sample, i.e. magnification, hardness load/test method. The signatory parties or their technical representatives that are present in the laboratory at the time shall make those decisions and give that information directly to the laboratory. Comments from other technical experts will be considered and factored into the signatory parties or their technical representative’s decisions but all decisions on protocol or samples shall remain as decisions of the signatory parties or their representatives.”

Thus, the sample locations, the tests to be performed, as well as details of the tests were chosen by the signatory parties or their technical representatives.

It was requested that the BETA Laboratory as a data collecting laboratory issue a Level 2 report without any interpretation or conclusion on any data obtained in the process of the laboratory tests, or any details on the photographs. All tests to be performed in the laboratory under the direct supervision of the signatory parties or their technical representative.

The Exchanger B arrived at the Halvorsen Company’s warehouse on August 23, 2010. The BETA LAB was informed the day before of the time of arrival at Halvorsen, but when BETA representative came to the warehouse, which was well before the time of reported arrival, the exchanger was already removed from the truck and unpacked. Thus the as arrived condition of the exchanger on the truck, as well as the integrity of the packaging could not be verified and recorded. The exchanger in as-unpacked condition at the Halvorsen is recorded on the photographs 1 through 10 of the previous report issued on 12/27/2010. Some general views of the unpacked exchanger are on Figures 2 and 3 of this report.

BETA LAB NO. M10329-B, TESORO EXCHANGER E6600-B EXAMINATION DATA	TESORO REFINING AND MARKETING COMPANY ANACORTES REFINERY	CUSTOMER P.O. NO.: 4501667904, CHANGE ORDER #1
PARTS: E6600B HEAT EXCHANGER, PARTS 1B, 4B, AND 5B	10200 W. MARCH POINT ROAD T91WA4428 ANACORTES, WA 98221	DATE: MARCH 8, 2011 PAGE 2 OF 52

LABORATORY REPORT

This report contains the results of evaluation of the samples contained in the Parts 1B, 4B, and 5B as labeled in Tables 2 and 3, and Figures 7 through 9.

This report is the second in a series of the reports on the parts removed from the E6600 heat exchanger "B" shell. The LW# and CW# refer to longitudinal and circumferential weld seams respectively, while the part number refers to the chain of custody number. Below is the list of issued reports, including this report, with information on the location of the mounts in the reports:

#	REPORT	DATE ISSUED	MOUNTS EXAMINED IN THE REPORT
1	M10329-A TESORO EXCHANGER E6600-B EXAMINATION DATA	12/27/2010	<ul style="list-style-type: none"> • PART 1B, WELD CW4, MOUNT CH4; • PART 2B, WELD LW3, MOUNT LH3; • PART 3B, TEE OF THE WELDS LH3 AND CH3 MOUNTS LM3 AND CH3
2	M10329-B TESORO EXCHANGER E6600-B EXAMINATION DATA	3/8/2011	<ul style="list-style-type: none"> • PART 1B, WELD CW4, MOUNT CH4-A; • PART 4B ON WELD LW2 APPROX. 36" FROM CW3, , MOUNT LH2; • PART 5B CONTAINS THE CW2/LW2 TEE (APPROX. 84" FROM CW3), MOUNTS LM2-T AND CH2

TEST PERFORMED: In previous report M10329-A issued on 12/27/2010 Parts 1B, 2B, and 3B were tested to identify the chemical composition of the base and weld metal, measure the hardness, and tensile properties, evaluate metallographic features of the mounts, measure the deepest damage location, as well as fracture surfaces in the scanning electron microscope (SEM).

As the continuation of this job it was requested to perform the following additional tests:

Visual examination, chemical analysis of the base and weld metal via vacuum spectrometry and carbon by LECO (cans 2 and 1 base metal, weld metal LW2 and CW2), macro and semi-micro hardness measurements of the base metal of the two cans, and traverse hardness across the CW2 and LW2 weld joints, photo microscopy (metallography), depth of the damage, damage location and width of the Coarse Grain HAZ (CG HAZ) and Fine Grain HAZ (FG HAZ) measured on all four mounts. The details of the apparatus utilized and the test procedures are given in Table 1 and Attachment 3.

BETA LAB NO.M10329-B, TESORO EXCHANGER E6600-B EXAMINATION DATA	TESORO REFINING AND MARKETING COMPANY ANACORTES REFINERY 10200 W. MARCH POINT ROAD T91WA4428 ANACORTES, WA 98221	CUSTOMER P.O. NO.: 4501667904, CHANGE ORDER #1
PARTS: E6600B HEAT EXCHANGER, PARTS 1B, 4B, AND 5B		DATE: MARCH 8, 2011
PAGE 3 OF 52		

LABORATORY REPORT

TEST RESULTS: The exchanger welds were labeled by others – CW signified circumferential weld, LW – longitudinal. The selection, location and labeling of the test samples as it shown on Figure 1, in Table 2, and on Figures 7 through 9 was done by others as well. The areas of the shell for the testing were chosen by others and consisted of three parts labeled Parts 1B (tested in the previous report as well), 4B, and 5B. Part 1B contained Cans 3 and 4 base metals and circumferential weld CW4 (one mount only); Part 4B had Can 2 base metal and a longitudinal weld LW2; Part 5B included Cans 2 and 1 base metals and a T-joint of longitudinal weld LW2 and circumferential weld CW2. The Part 1B was located to include indications found in the welds by NDE (done by others). The heat exchanger with the parts marked and consequently cut out is shown on Figures 5 and 6, the samples layout photographs and sketches, as well as the tables indicating the tests to be performed are on Figures 7 through 9.

Three samples each from the Parts 4B and 5B were selected by others for: a). chemical analysis of the base metal (cans 1 and 2), b). base metal Rockwell hardness measurements performed at the wall thickness middle line, c). weld metal chemistry (welds CW2 and LW2 performed at the cap and the root of the welds), and d). semi-micro hardness measurements of the two weld joints across the welds. The results are in Tables 4 (Rockwell hardness of the base metal), 5 through 7 (traverse hardness), and 8 (chemical composition of the base and weld metals).

Four samples were selected by others to be mounted for evaluation of the microstructure. The mounted and polished samples were examined as directed by and under supervision of others in un-etched and etched conditions by optical metallographic microscope at the magnifications 15x, 50x, and 200x. The photographs which were taken as selected by others are on Figures 10 through 18.

In addition to taking selected photomicrographs of areas of interest through the thickness, it was requested to measure the following parameters in the microstructure of the welded joints: the depth and the location of the damage, as well as the widths of the coarse grain HAZ (CG HAZ) and fine grain of the HAZ (FG HAZ) at the deepest damage location. The results are in Table 9.

Semi-micro Vickers hardness under 500 g load were performed, as directed by others, across the welds. The Vickers hardness numbers were converted to Rockwell Scale B hardness numbers. The results are plotted on Figures 19 and 20 and in Tables 5 through 7.

<p><small>This interpretive report is a result of testing/analysis derived from material, information and/or specifications furnished by the customer and is confidential and is intended for the customer only. If you are receiving it in error, please advise immediately. Further, you are prohibited from disclosing, copying, distributing or using any of this information without written approval from Beta Lab. This report shall not be reproduced except in its entirety and, in any case, without prior written approval from Beta Lab. Except for such obligations as are set forth in the Agreement between Beta Lab and its customer for whom this work has been performed, neither the party preparing this report nor any person acting on its behalf: Makes any warranty or representation, express or implied, including merchantability or fitness for a particular purpose, with respect to the accuracy, completeness or usefulness of the information contained in this report, or that the use of any information, apparatus method or process disclosed from this report does not infringe upon privately owned rights or intellectual property; or Assumes any liability with respect to the use of, or for damages, including consequential or punitive damages, resulting from the use of, any information, apparatus, method or process disclosed in this report.</small></p>

BETA LAB NO.M10329-B, TESORO EXCHANGER E6600-B EXAMINATION DATA	TESORO REFINING AND MARKETING COMPANY ANACORTES REFINERY 10200 W. MARCH POINT ROAD T91WA4428 ANACORTES, WA 98221	CUSTOMER P.O. NO.: 4501667904, CHANGE ORDER #1
		DATE: MARCH 8, 2011
PARTS: E6600B HEAT EXCHANGER, PARTS 1B, 4B, AND 5B		PAGE 4 OF 52

LABORATORY REPORT

TABLE 1
TESTS PERFORMED IN THIS REPORT
(See Attachment 3 for Test/Equipment Specifications)

TEST	METHOD OR INSTRUMENT	PERFORMED BY	LOCATION, DATE	RESULTS LOCATION
VISUAL EXAMINATION	LECO SZH STEREO MICROSCOPE OR PORTRAIT CAMERA	J. BLOUGH AND M. BRIDAVSKY	BETA, VARIOUS	TEST RESULTS
ROCKWELL HARDNESS	WILSON ROCKWELL HARDNESS TESTER	M. TASCAR	BETA, 2/24/2011	TABLE 4
SEMI-MACRO VICKERS	INSTRON TUKON 2100B HARDNESS TESTER, MODEL T2100BR1942	M. TASCAR	BETA, 2/25 AND 2/28/2011	TABLES 5 THROUGH 7
OPTICAL METALLOGRAPHY	LECO PMG-3 OPTICAL MICROSCOPE	M. BRIDAVSKY	BETA, VARIOUS	FIGURES 12 THROUGH 18
LINEAR MEASUREMENTS	LECO PMG-3 OPTICAL MICROSCOPE WITH BUEHLER OMNIMET SYSTEM	M. BRIDAVSKY	BETA, VARIOUS	TABLE 9
CHEMICAL ANALYSIS	THERMO ARL-3460 OE SPECTROMETER	M. TASCAR	BETA, 2/25/2011	TABLE 8
Chemical (Carbon) Analysis	LECO CARBON DETERMINATION CS-444	M. Belviso	BETA, 2/25/2011	TABLE 8

BETA LAB No.M10329-B, TESORO EXCHANGER E6600-B EXAMINATION DATA	TESORO REFINING AND MARKETING COMPANY ANACORTES REFINERY 10200 W. MARCH POINT ROAD T91WA4428 ANACORTES, WA 98221	CUSTOMER P.O. No.: 4501667904, CHANGE ORDER #1
PARTS: E6600B HEAT EXCHANGER, PARTS 1B, 4B, AND 5B		DATE: MARCH 8, 2011
PAGE 5 OF 52		

LABORATORY REPORT

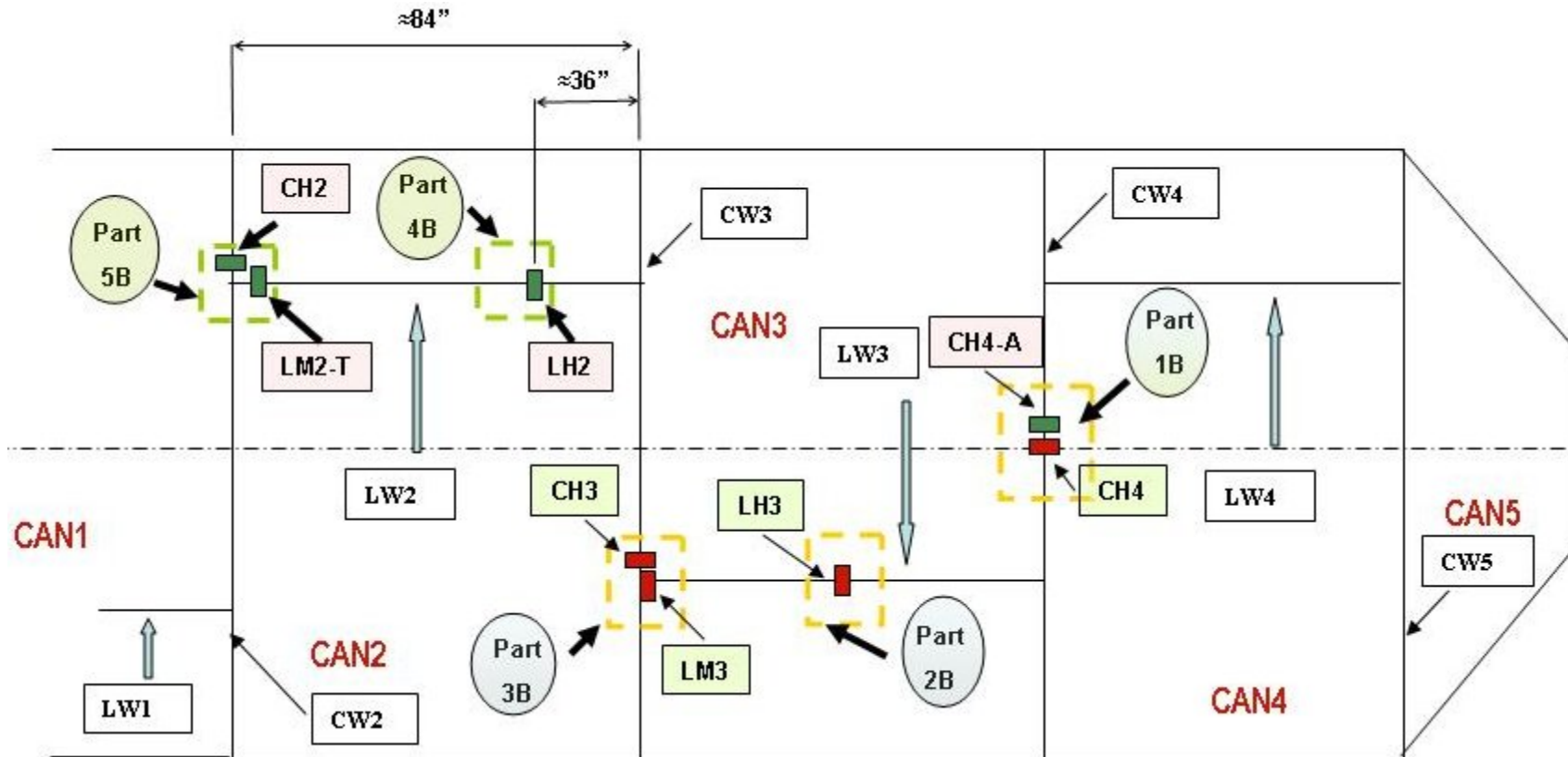

Figure 1. Layout of the samples evaluated in two reports -10329-A of 12/27/2010 (fill color red) and this report M10329-B (fill color green). You are looking at the OD of the shell. Not to scale.

BETA LAB NO.M10329-B, TESORO EXCHANGER E6600-B EXAMINATION DATA	TESORO REFINING AND MARKETING COMPANY ANACORTES REFINERY 10200 W. MARCH POINT ROAD T91WA4428 ANACORTES, WA 98221	CUSTOMER P.O. NO.: 4501667904, CHANGE ORDER #1
		DATE: MARCH 8, 2011
PARTS: E6600B HEAT EXCHANGER, PARTS 1B, 4B, AND 5B		PAGE 6 OF 52

LABORATORY REPORT

TABLE 2
SUMMARY OF TESTS/SAMPLES

PART NUMBER	LOCATION	SAMPLE ID	TESTS				
			CHEMISTRY		METALLOGRAPHY	HARDNESS TRAVERSE	BM ROCKWELL HARDNESS
			WELD	BASE METAL			
1B	CW4	CH4-A	-	-	1	NO	-
4B	LW2	N2	-	1	-	-	-
		L2	1	-	-	-	-
		LH2	-	-	1	Yes	-
		R2	-	-	-	-	1
5B	LW2/CW2 Tee	C2	1	-	-	-	-
		N1	-	1	-	-	-
		R1	-	-	-	-	1
		CH2	-	-	1	Yes	-
		LM2-T	-	-	1	NO	-
Total samples			2	2	4	2	2

- not applicable

TABLE 3
TOTALS OF SAMPLES PER TEST

TEST	NUMBER OF SAMPLES
CHEMISTRY	4
METALLOGRPHY	4
HARDNESS TRAVERSE	2
ROCKWELL HARDNESS OF BASE METAL (BM)	2

BETA LAB NO. M10329-B, TESORO EXCHANGER E6600-B EXAMINATION DATA	TESORO REFINING AND MARKETING COMPANY ANACORTES REFINERY 10200 W. MARCH POINT ROAD T91WA4428 ANACORTES, WA 98221	CUSTOMER P.O. NO.: 4501667904, CHANGE ORDER #1
		DATE: MARCH 8, 2011
PARTS: E6600B HEAT EXCHANGER, PARTS 1B, 4B, AND 5B		PAGE 7 OF 52

LABORATORY REPORT

TABLE 4
ROCKWELL (HRB) HARDNESS MEASUREMENTS
ON PLATE CROSS SECTIONS

SAMPLE IDENTIFICATION	HARDNESS, HRB				DATA LOCATION
	MINIMUM	MAXIMUM	AVERAGE	NUMBER OF INDENTATIONS	
1B – R4 (CAN 4)	72	76	74	10	PREVIOUS REPORT M10329-A TESORO EXCHANGER E6600-B EXAMINATION DATA, ISSUED 12/27/2010
2B – R3 (CAN 3)	74	81	77	10	
3B – R2 (CAN 2)	80	85	83	10	
4B – R2 (CAN 2)	83	87	85	10	CURRENT REPORT M10329-B TESORO EXCHANGER E6600-B EXAMINATION DATA, ISSUED 3/3/2011
5B – R1 (CAN 1)	80	86	83	10	

TABLE 5

SEMI-MICRO VICKERS 500g (HV⁵⁰⁰) MEASUREMENTS
OF TRAVERSES CONVERTED TO ROCKWELL SCALE B
4B-LH2
See Graphs on Figure 19

Line	Zone	Hardness, HV ⁵⁰⁰			Number of Indentations
		Minimum	Maximum	Average	
1 - (OD)	BM Can 2	85	90	87	13
	HAZ 2	90	98	NA	6
	Weld LH2	83	95	88	56
	HAZ 2	88	95	NA	4
	BM Can 2	81	90	87	11
2 (Middle)	BM Can 2	84	91	88	15
	HAZ 2	82	90	NA	11
	Weld LH2	82	92	86	27
	HAZ 2	83	93	NA	9
	BM Can 2	83	89	85	12
3 - (ID)	BM Can 2	80	87	84	10
	HAZ 2	84	96	NA	10
	Weld LH2	85	93	89	55
	HAZ 2	85	88	NA	5
	BM Can 2	83	87	85	11

BETA LAB NO.M10329-B, TESORO EXCHANGER E6600-B EXAMINATION DATA	TESORO REFINING AND MARKETING COMPANY ANACORTES REFINERY 10200 W. MARCH POINT ROAD T91WA4428 ANACORTES, WA 98221	CUSTOMER P.O. NO.: 4501667904, CHANGE ORDER #1
		DATE: MARCH 8, 2011
PARTS: E6600B HEAT EXCHANGER, PARTS 1B, 4B, AND 5B		PAGE 8 OF 52

LABORATORY REPORT

TABLE 6

**SEMI-MICRO VICKERS 500g (HV⁵⁰⁰) MEASUREMENTS
OF TRAVERSES CONVERTED TO ROCKWELL SCALE B
5B-CH2**

See Graphs on Figure 20

Line	Zone	Hardness, HV ⁵⁰⁰			Number of Indentations
		Minimum	Maximum	Average	
1 - (OD)	BM Can 2	82	89	86	13
	HAZ 2	85	96	NA	9
	Weld CH2	79	91	84	49
	HAZ 1	86	94	NA	9
	BM Can 1	82	87	85	11
2 (Middle)	BM Can 2	81	88	84	14
	HAZ 2	84	87	NA	6
	Weld CH2	78	85	81	21
	HAZ 1	85	86	NA	5
	BM Can 1	80	84	82	11
3 - (ID)	BM Can 2	83	90	87	11
	HAZ 2	89	94	NA	11
	Weld CH2	84	92	88	32
	HAZ 1	90	95	NA	8
	BM Can 1	85	93	88	11

BETA LAB NO. M10329-B, TESORO EXCHANGER E6600-B EXAMINATION DATA	TESORO REFINING AND MARKETING COMPANY ANACORTES REFINERY 10200 W. MARCH POINT ROAD T91WA4428 ANACORTES, WA 98221	CUSTOMER P.O. NO.: 4501667904, CHANGE ORDER #1
		DATE: MARCH 8, 2011
PARTS: E6600B HEAT EXCHANGER, PARTS 1B, 4B, AND 5B		PAGE 9 OF 52

LABORATORY REPORT

TABLE 7

**SUMMARY OF MICRO-HARDNESS NUMBERS
FROM TABLES 6 THROUGH 8 FROM REPORT M10329-A
AND TABLES 5 AND 6 FROM THIS REPORT**

VICKERS 500G (HV⁵⁰⁰) CONVERTED TO ROCKWELL SCALE B

LOCATION	MIN	MAX	AVERAGE	DATA LOCATION
Base Metal Can 4	73	79	76	PREVIOUS REPORT M10329-A TESORO EXCHANGER E6600-B EXAMINATION DATA, ISSUED 12/27/2010
Base Metal Can 3	71	92	82	
Base Metal Can 2	82	92	87	
HAZ Can 4	73	79	76	
HAZ Can 3	72	100	86	
HAZ Can 2	82	94	88	
Weld Metal CW4 (CH4)	73	88	79	
Weld Metal LW3 (LH3)	81	94	85	
Weld Metal CW3 (CH3)	80	96	86	
Base Metal Can 2	80	90	85	CURRENT REPORT M10329-B TESORO EXCHANGER E6600-B EXAMINATION DATA, ISSUED 3/3/2011
Base Metal Can 1	80	93	87	
HAZ Can 2	84	98	NA	
HAZ Can 1	85	95	NA	
Weld Metal LW2 (LH2)	83	95	89	
Weld Metal CW2 (CH2)	78	92	85	

BETA LAB NO. M10329-B, TESORO EXCHANGER E6600-B EXAMINATION DATA	TESORO REFINING AND MARKETING COMPANY ANACORTES REFINERY 10200 W. MARCH POINT ROAD T91WA4428 ANACORTES, WA 98221	CUSTOMER P.O. NO.: 4501667904, CHANGE ORDER #1
		DATE: MARCH 8, 2011
PARTS: E6600B HEAT EXCHANGER, PARTS 1B, 4B, AND 5B		PAGE 10 OF 52

LABORATORY REPORT

**TABLE 8
CHEMICAL ANALYSIS OF BASE METAL AND WELD DEPOSITS**

SAMPLE IDENTIFICATION	CHEMICAL COMPOSITION, WT. %												DATA LOCATION	
	C	Si	P	S	Mn	Ni	Cr	Mo	V	Cu	Co	AL		
CAN4 (PART 1B – N4)	0.27	0.25	0.008	0.030	0.66	0.11	0.10	0.03		0.13	0.01	0.006	PREVIOUS REPORT M10329-A ISSUED 12/27/2010	
CAN3 (PART 2B – N3)	0.25	0.23	0.008	0.020	0.60	0.12	0.13	0.02		0.18	0.01	0.008		
CAN2 (PART 3B – N2)	0.28	0.23	0.009	0.021	0.62	0.12	0.13	0.03		0.18	0.01	0.006		
CAN1 (PART 5B – N1)	0.26	0.24	0.009	0.023	0.62	0.12	0.13	0.02	0.0005	0.18	0.01	0.005	CURRENT REPORT M10329-B, ISSUED 3/3/2011	
CAN2 (PART 4B – N2)	0.27	0.24	0.009	0.023	0.62	0.12	0.13	0.02	0.0005	0.18	0.01	0.005		
SA- 515 GRADE 70	0.31 MAX	0.13- 0.45	0.035 MAX	0.035 MAX	1.30 MAX	NS	NS	NS	NS	NS	NS	NS	STANDARD	
WELD CW4 AT CAP (OD) - C4	0.15	0.43	0.010	0.019	0.99	0.08	0.09	0.02	0.000	0.15	0.01	0.007	PREVIOUS M10329-A, ISSUED 12/27/2010	
WELD LW3 – L3	AT CAP (OD)	0.09	0.55	0.011	0.018	1.15	0.06	0.07	0.01	0.001	0.14	0.01		0.007
	AT ROOT (ID)	0.12	0.45	0.011	0.020	1.03	0.08	0.08	0.02	0.001	0.15	0.01		0.008
WELD CW3 – C3	AT CAP (OD)	0.09	0.57	0.011	0.018	1.13	0.06	0.07	0.01	0.001	0.15	0.01		0.006
	AT ROOT (ID)	0.09	0.60	0.012	0.020	1.29	0.05	0.06	0.01	0.002	0.13	0.01		0.007
WELD LW2 – L2	AT CAP (OD)	0.08	0.56	0.011	0.020	1.14	0.06	0.07	0.01	0.0012	0.14	0.01	0.007	
	AT ROOT (ID)	0.13	0.48	0.011	0.020	1.08	0.07	0.08	0.02	0.001	0.14	0.01	0.005	
WELD CW2 – C2	AT CAP (OD)	0.09	0.55	0.011	0.019	1.14	0.05	0.07	0.01	0.002	0.14	0.01	0.005	
	AT ROOT (ID)	0.11	0.64	0.012	0.020	1.28	0.05	0.06	0.01	0.002	0.13	0.01	0.006	
SFA 5.1 (E7016, E7018)*	NS	0.75 MAX	NS	NS	1.60 MAX	0.30 MAX	0.20 MAX	0.30 MAX	0.08 MAX	NS	NS	NS	STANDARDS	
SFA 5.17 (EM11K)	0.07 - 0.15	0.65- 0.85	0.030 MAX	0.025 MAX	1.00 - 1.50	NS	NS	NS	NS	0.35	NS	NS		
SFA 5.17 (EL12)	0.04 - 0.14	0.10 MAX	0.030 MAX	0.030 MAX	0.25 0.60	NS	NS	NS	NS	0.35	NS	NS		
SFA 5.17 (EM12K)	0.05 - 0.15	0.10- 0.35	0.030 MAX	0.030 MAX	0.80 - 1.25	NS	NS	NS	NS	0.35	NS	NS		

NS = NOT SPECIFIED

ALL ANALYSIS IS OPTICAL EMISSION SPECTROSCOPY EXCEPT THE CARBON WHICH IS LECO

NO ALLOYS OR WELD WIRE GRADES WERE SPECIFIED SO TYPICAL ARE PRESENTED

* TOTAL OF MN+NI+CR+MO+V = 1.75 MAX

SA-515 SPECIFICATION FOR PRESSURE VESSEL PLATES, CARBON STEEL, FOR INTERMEDIATE-AND HIGHER-TEMPERATURE SERVICE – JULY 2003 ADDENDUM

SFA 5.1 SPECIFICATION FOR CARBON STEEL ELECTRODES FOR SHIELD METAL ARC WELDING-JULY 2003 ADDENDUM

SFA 5.17 SPECIFICATION FOR CARBON STEEL ELECTRODES AND FLUXES FOR SUBMERGED ARC WELDING- JULY 2003 ADDENDUM

BETA LAB NO. M10329-B, TESORO EXCHANGER E6600-B EXAMINATION DATA	TESORO REFINING AND MARKETING COMPANY ANACORTES REFINERY	CUSTOMER P.O. NO.: 4501667904, CHANGE ORDER #1
PARTS: E6600B HEAT EXCHANGER, PARTS 1B, 4B, AND 5B	10200 W. MARCH POINT ROAD T91WA4428 ANACORTES, WA 98221	DATE: MARCH 8, 2011
PAGE 11 OF 52		

LABORATORY REPORT

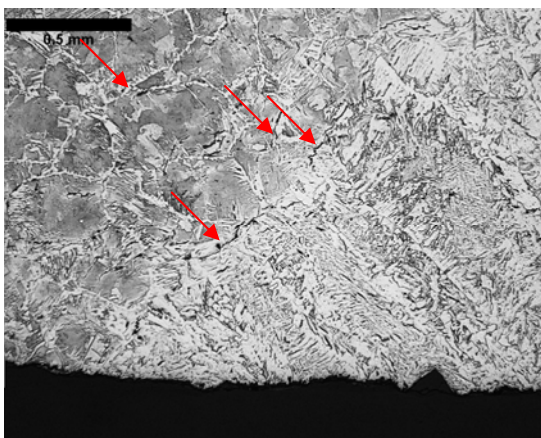

A

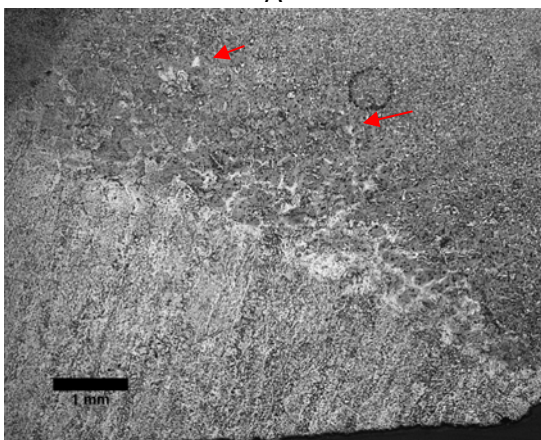

B

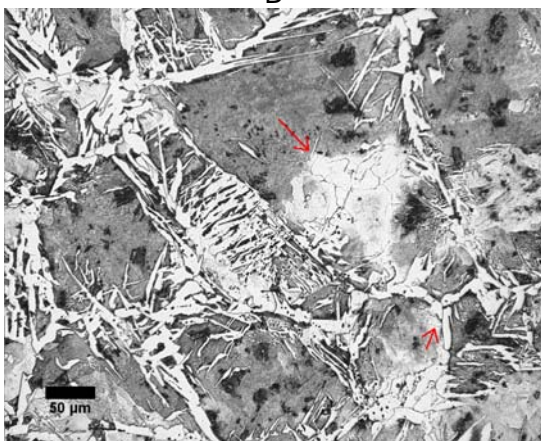

C

When the observed damage is located at the fusion line (FL) or at the 1st or 2nd grain of the CG HAZ (Coarse Grain of the Heat Affected Zone, CG everywhere in this report), it is marked as **“FL”**

It is typical to find damage beyond the FL and the 2nd grain of the CG, as it shown on the micrographs at left. The arrows at the microphotograph [B] show a decarburized spot indicative of the damage well deep in the CG, away from the FL. On microphotograph [C] the damage is in the 21st – 22nd grain inside the CG.

If this is observed, the location of the damage is defined as **“CG”**.

If both, fusion line and coarse grain area are affected (which is most often the case), the location is defined as **“FL/CG”**

Figure 2. Definitions of the damage locations (devised by others) used in Table 9 and in the text

BETA LAB NO.M10329-B, TESORO EXCHANGER E6600-B EXAMINATION DATA	TESORO REFINING AND MARKETING COMPANY ANACORTES REFINERY 10200 W. MARCH POINT ROAD T91WA4428 ANACORTES, WA 98221	CUSTOMER P.O. No.: 4501667904, CHANGE ORDER #1
		DATE: MARCH 8, 2011
PARTS: E6600B HEAT EXCHANGER, PARTS 1B, 4B, AND 5B		PAGE 12 OF 52

LABORATORY REPORT

TABLE 9
DEPTH AND LOCATION OF THE DAMAGE

LOCATION OF THE SAMPLES		SAMPLE LABEL	DAMAGE DEPTH FROM ID						DAMAGE LOCATION		WIDTH AT THE DEEPEST DAMAGE, MM				MICROGRAPHS FIGURE No.	DATA LOCATION
PART NUMBER AND WELD	MACRO PHOTOS		LEFT OF WELD			RIGHT OF WELD			LEFT OF WELD	RIGHT OF WELD	COARSE GRAIN HAZ		FINE GRAIN HAZ			
			MM	%*	CAN	MM	%*	CAN			LEFT OF WELD	RIGHT OF WELD	LEFT OF WELD	RIGHT OF WELD		
PART 1B, WELD CW4		CH4	5.14	24	3	S.S. CLAD		4	BM	S.S. CLAD	0.38	NA	1.12	NA	26	PREVIOUS REPORT M10398-A ISSUED ON 12/27/10
PART 2B, WELD LW3		LH3	13.94	64	3	5.02	23	3	FL/CG	FL/CG	0.46	1.90	1.50	5.05	29	
PART 3B, WELDS LW3 AND CW3 TEE	CW3	CH3	2.49	11	2	3.74	17	3	FL/CG	FL/CG	0.66	0.87	1.62	1.07	34 AND 37	
	LW3	LM3	1.71	8	3	1.91	9	3	FL/CG	FL/CG	1.45	2.44	3.40	2.73	39 AND 40	

BETA LAB NO. M10329-B, TESORO EXCHANGER E6600-B EXAMINATION DATA	TESORO REFINING AND MARKETING COMPANY ANACORTES REFINERY 10200 W. MARCH POINT ROAD T91WA4428 ANACORTES, WA 98221	CUSTOMER P.O. NO.: 4501667904, CHANGE ORDER #1
PARTS: E6600B HEAT EXCHANGER, PARTS 1B, 4B, AND 5B		DATE: MARCH 8, 2011
PAGE 13 OF 52		

LABORATORY REPORT

TABLE 9 (CONTINUED)
DEPTH AND LOCATION OF THE DAMAGE

LOCATION OF THE SAMPLES		SAMPLE LABEL	DAMAGE DEPTH FROM ID						DAMAGE LOCATION		WIDTH AT THE DEEPEST DAMAGE, MM				MICROGRAPHS FIGURE NO.	DATA LOCATION	
PART NUMBER AND WELD	MACRO PHOTOS		LEFT OF WELD			RIGHT OF WELD			LEFT OF WELD	RIGHT OF WELD	COARSE GRAIN HAZ		FINE GRAIN HAZ				
			MM	%*	CAN	MM	%*	CAN			LEFT OF WELD	RIGHT OF WELD	LEFT OF WELD	RIGHT OF WELD			
PART 1B, WELD CW4		CH4-A	7.97	37	3	S.S. CLAD			4	BM	NA	NA	NA	NA	NA	14	CURRENT REPORT M10398-B
PART 4B, WELD LW2		LH2	3.58	16	2	3.06	14	2	FL	FL	2.42	2.48	3.9 9	3.48	15 & 16		
PART 5B, WELDS LW2 AND CW2 TEE	CW2	CH2	0	0	1	0	0	2	NA	NA	NA	NA	NA	NA	17		
	LW2	LM2-T	0	0	2	0	0	2	NA	NA	NA	NA	NA	NA	18		

BETA LAB No.M10329-B, TESORO EXCHANGER E6600-B EXAMINATION DATA	TESORO REFINING AND MARKETING COMPANY ANACORTES REFINERY 10200 W. MARCH POINT ROAD T91WA4428 ANACORTES, WA 98221	CUSTOMER P.O. No.: 4501667904, CHANGE ORDER #1
PARTS: E6600B HEAT EXCHANGER, PARTS 1B, 4B, AND 5B		DATE: MARCH 8, 2011
		PAGE 14 OF 52

LABORATORY REPORT

**6600-B HEAT EXCHANGER
IN AS UNPACKED CONDITION.
INITIAL RECEIPT**

BETA LAB NO. M10329-B, TESORO EXCHANGER
E6600-B EXAMINATION DATA

PARTS: E6600B HEAT EXCHANGER, PARTS 1B, 4B,
AND 5B

TESORO REFINING AND MARKETING COMPANY
ANACORTES REFINERY
10200 W. MARCH POINT ROAD T91WA4428
ANACORTES, WA 98221

CUSTOMER P.O. NO.: 4501667904,
CHANGE ORDER #1

DATE: MARCH 8, 2011

PAGE 15 OF 52

LABORATORY REPORT



Figure 3
E6600-B Exchanger on the warehouse floor

BETA LAB NO.M10329-B, TESORO EXCHANGER E6600-B EXAMINATION DATA	TESORO REFINING AND MARKETING COMPANY ANACORTES REFINERY	CUSTOMER P.O. NO.: 4501667904, CHANGE ORDER #1
PARTS: E6600B HEAT EXCHANGER, PARTS 1B, 4B, AND 5B	10200 W. MARCH POINT ROAD T91WA4428 ANACORTES, WA 98221	DATE: MARCH 8, 2011 PAGE 16 OF 52

LABORATORY REPORT



Figure 4
Manufacturers' plates

BETA LAB No.M10329-B, TESORO EXCHANGER E6600-B EXAMINATION DATA	TESORO REFINING AND MARKETING COMPANY ANACORTES REFINERY 10200 W. MARCH POINT ROAD T91WA4428 ANACORTES, WA 98221	CUSTOMER P.O. No.: 4501667904, CHANGE ORDER #1
PARTS: E6600B HEAT EXCHANGER, PARTS 1B, 4B, AND 5B		DATE: MARCH 8, 2011
		PAGE 17 OF 52

LABORATORY REPORT

E6600 HEAT EXCHANGER “B”
SHELL PARTS 4B and 5B
AND
SPECIMENS LAYOUT

BETA LAB NO.M10329-B, TESORO EXCHANGER E6600-B EXAMINATION DATA	TESORO REFINING AND MARKETING COMPANY ANACORTES REFINERY	CUSTOMER P.O. NO.: 4501667904, CHANGE ORDER #1
PARTS: E6600B HEAT EXCHANGER, PARTS 1B, 4B, AND 5B	10200 W. MARCH POINT ROAD T91WA4428 ANACORTES, WA 98221	DATE: MARCH 8, 2011 PAGE 18 OF 52

LABORATORY REPORT



TESORO Exchanger E6600B as received at Halvorsen with the Parts 4 and 5 marked for cutting

Figure 5.Shell

BETA LAB NO. M10329-B, TESORO EXCHANGER E6600-B EXAMINATION DATA	TESORO REFINING AND MARKETING COMPANY ANACORTES REFINERY 10200 W. MARCH POINT ROAD T91WA4428 ANACORTES, WA 98221	CUSTOMER P.O. NO.: 4501667904, CHANGE ORDER #1
PARTS: E6600B HEAT EXCHANGER, PARTS 1B, 4B, AND 5B		DATE: MARCH 8, 2011
PAGE 19 OF 52		

LABORATORY REPORT

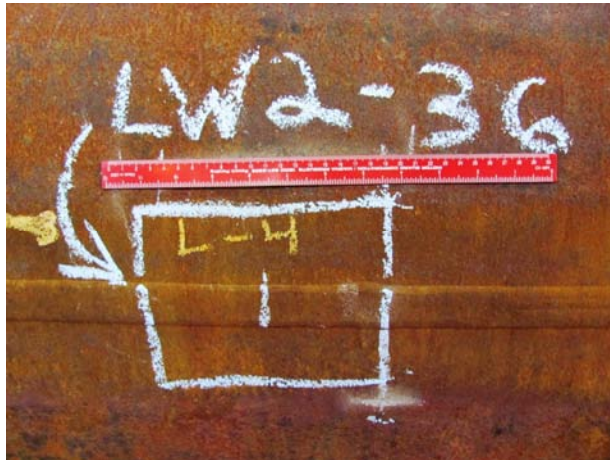

Part 4B, approximate location on the weld LW2, 36" from the weld CW3

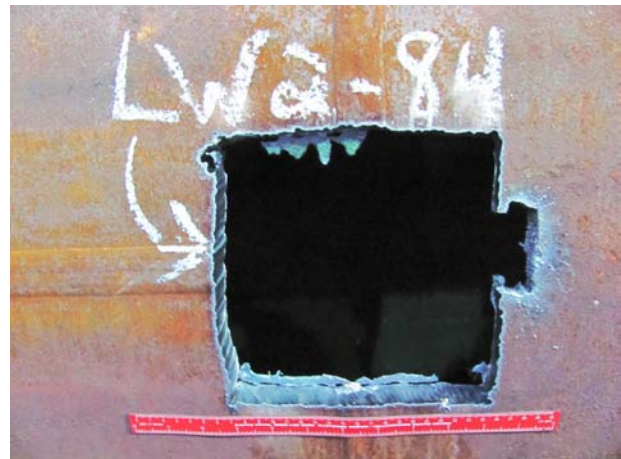

Part 5B, located on the LW2/CW2 Tee approximately 84" from the weld CW3

Figure 6.

BETA LAB NO. M10329-B, TESORO EXCHANGER E6600-B EXAMINATION DATA	TESORO REFINING AND MARKETING COMPANY ANACORTES REFINERY 10200 W. MARCH POINT ROAD T91WA4428 ANACORTES, WA 98221	CUSTOMER P.O. NO.: 4501667904, CHANGE ORDER #1
PARTS: E6600B HEAT EXCHANGER, PARTS 1B, 4B, AND 5B		DATE: MARCH 8, 2011
PAGE 21 OF 52		

LABORATORY REPORT

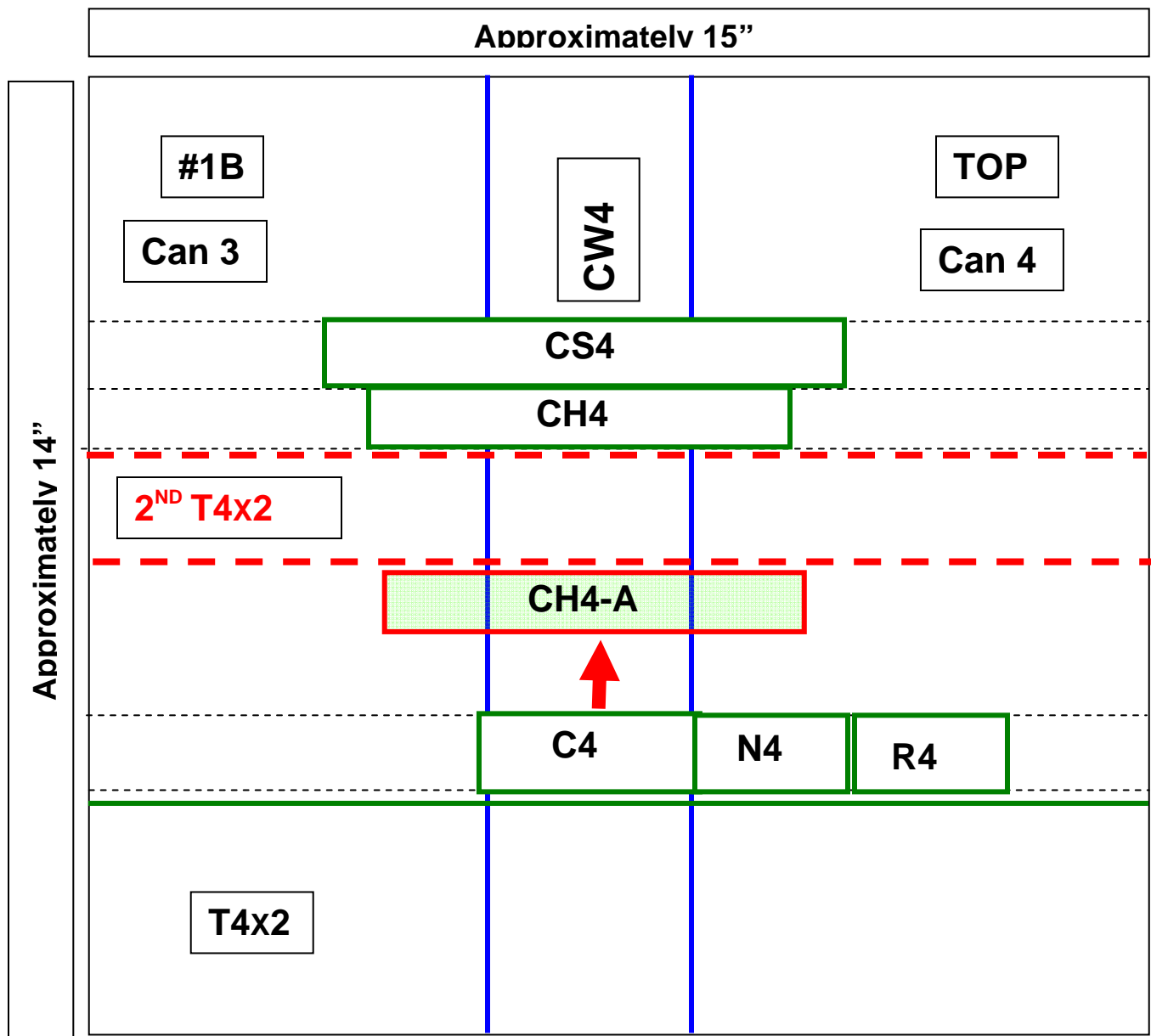
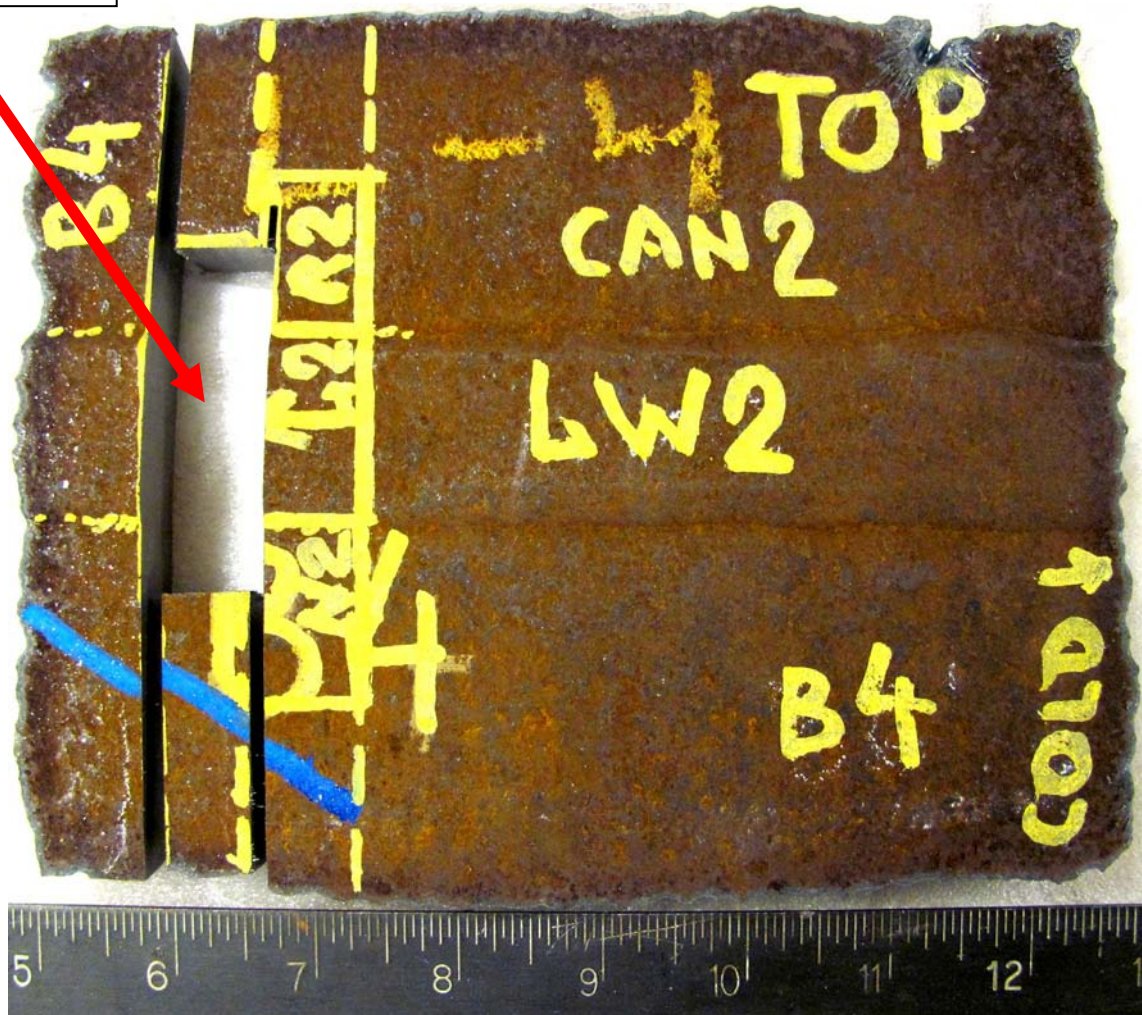

Figure 7b. Part 1B CW4 samples layout sketch. Only one sample CH4-A was evaluated in this report (metallography). The rest of the samples were evaluated in the previous report M10398-A, issued on 12/27/2010. See Figure 7a above for the photograph of the samples layout. The red arrow indicates the polished face. You are looking at O.D.

BETA LAB NO. M10329-B, TESORO EXCHANGER E6600-B EXAMINATION DATA	TESORO REFINING AND MARKETING COMPANY ANACORTES REFINERY 10200 W. MARCH POINT ROAD T91WA4428 ANACORTES, WA 98221	CUSTOMER P.O. NO.: 4501667904, CHANGE ORDER #1
PARTS: E6600B HEAT EXCHANGER, PARTS 1B, 4B, AND 5B		DATE: MARCH 8, 2011
PAGE 22 OF 52		

LABORATORY REPORT

**LH2-T MOUNT
REMOVED**



SAMPLE IDENTIFICATION	TEST
N2	CHEMISTRY OF BM CAN 2
L2	CHEMISTRY OF WM LW2
LH2	METALLOGRAPHY AND TRAVERSE HARDNESS OF LW2 (ARROW POINTS AT POLISHED FACE)
R2	ROCKWELL HARDNESS OF BM CAN 3

Figure 8a. Specimens layout and labeling. You are looking at O.D.

BETA LAB NO.M10329-B, TESORO EXCHANGER E6600-B EXAMINATION DATA	TESORO REFINING AND MARKETING COMPANY ANACORTES REFINERY	CUSTOMER P.O. NO.: 4501667904, CHANGE ORDER #1
PARTS: E6600B HEAT EXCHANGER, PARTS 1B, 4B, AND 5B	10200 W. MARCH POINT ROAD T91WA4428 ANACORTES, WA 98221	DATE: MARCH 8, 2011 PAGE 23 OF 52

LABORATORY REPORT

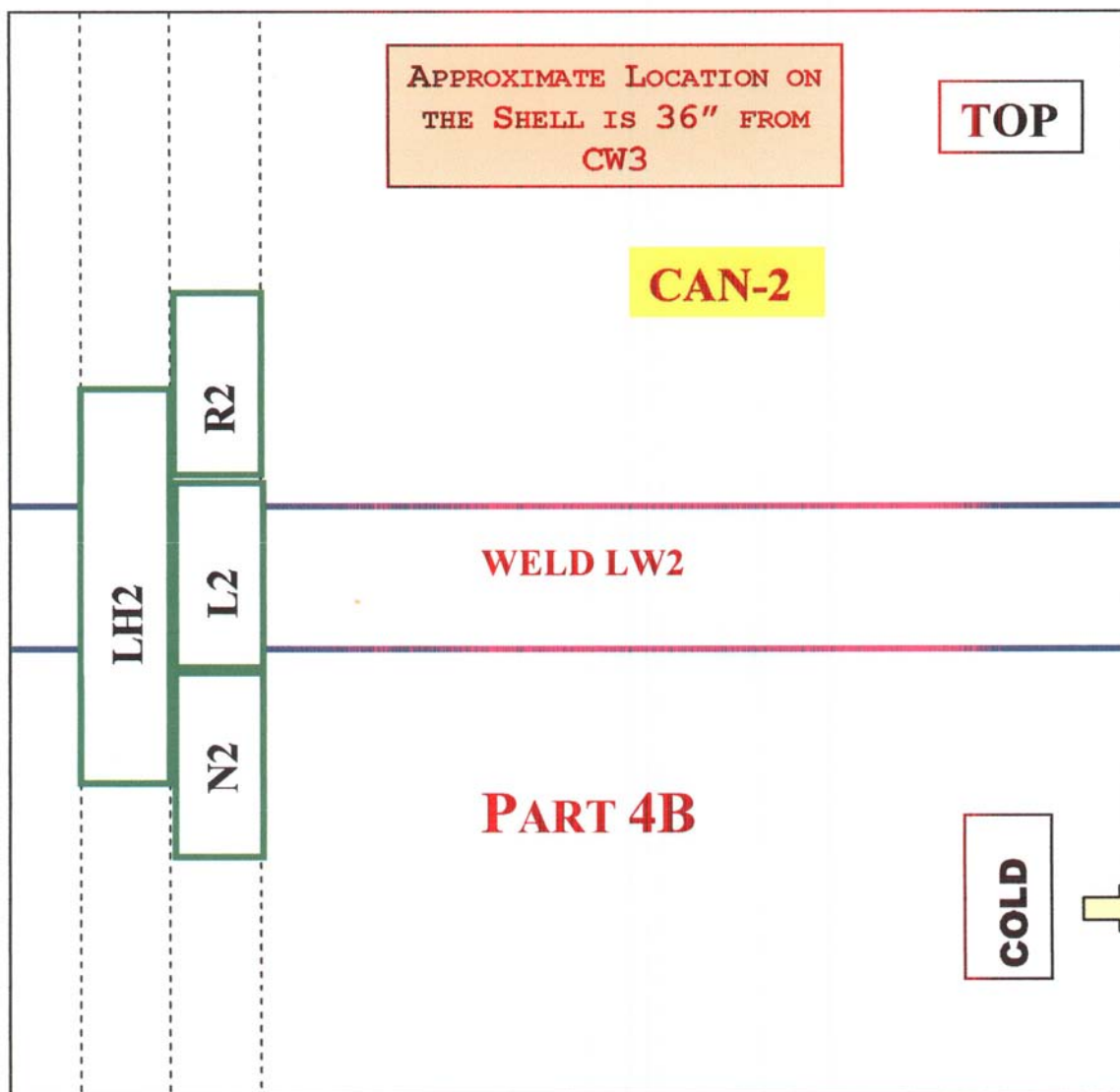
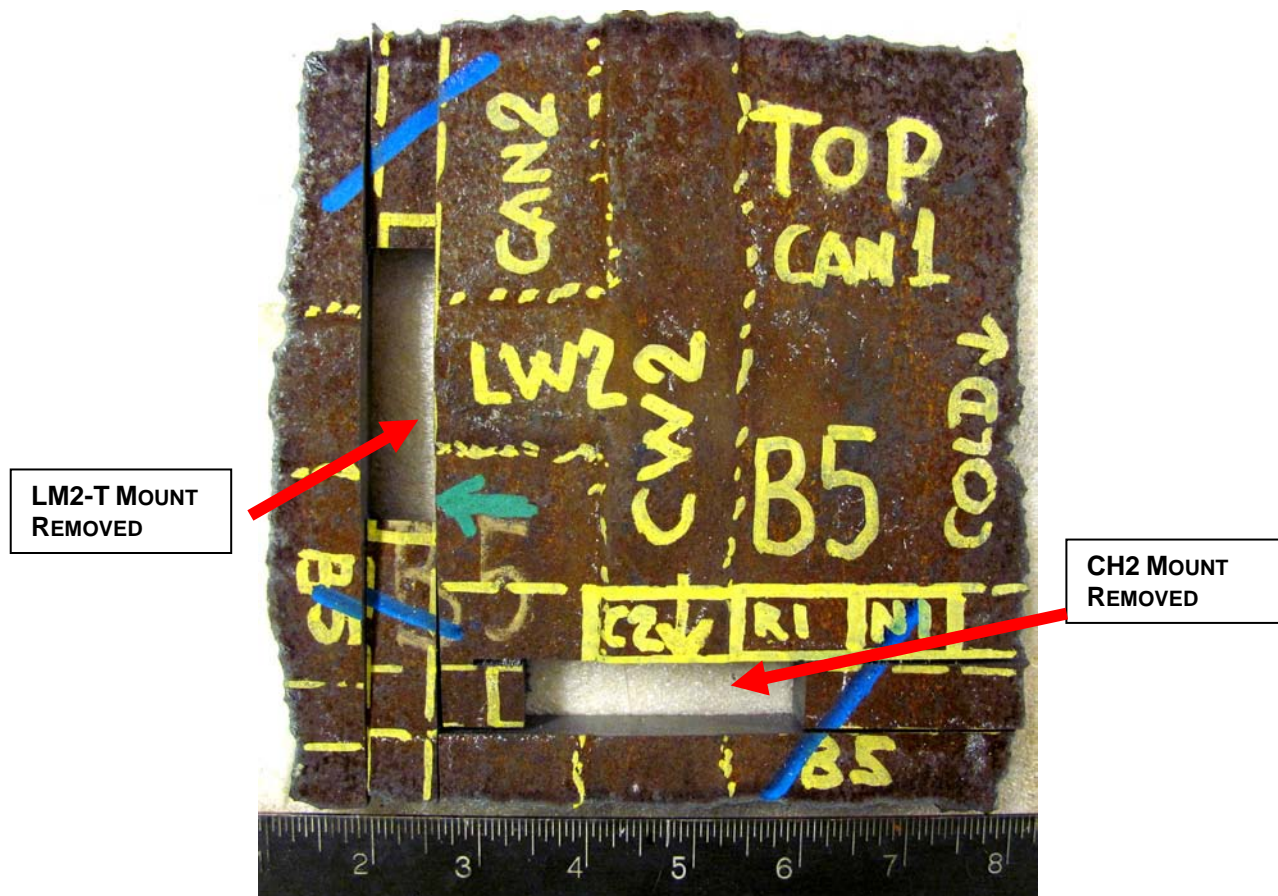

Figure 8b. Sketch of the specimens' layout and labeling. The photograph of the samples labeled and the table with the test to be performed are on Figure 8a above. You are looking at O.D.

BETA LAB NO. M10329-B, TESORO EXCHANGER E6600-B EXAMINATION DATA	TESORO REFINING AND MARKETING COMPANY ANACORTES REFINERY 10200 W. MARCH POINT ROAD T91WA4428 ANACORTES, WA 98221	CUSTOMER P.O. NO.: 4501667904, CHANGE ORDER #1
PARTS: E6600B HEAT EXCHANGER, PARTS 1B, 4B, AND 5B		DATE: MARCH 8, 2011
PAGE 24 OF 52		

LABORATORY REPORT



#5B – CW2-LW2

SAMPLE IDENTIFICATION	TEST
N1	CHEMISTRY OF BM CAN 1
C2	CHEMISTRY OF WELD METAL CW2
CH2	METALLOGRAPHY AND TRAVERSE HARDNESS OF CW2 (ARROW POINTS AT POLISHED FACE)
LM2-T	METALLOGRAPHY OF LW2 (ARROW POINTS AT POLISHED FACE)
R1	ROCKWELL HARDNESS OF CAN 2

Figure 9a. Specimens layout and labeling. You are looking at O.D.

BETA LAB NO. M10329-B, TESORO EXCHANGER E6600-B EXAMINATION DATA	TESORO REFINING AND MARKETING COMPANY ANACORTES REFINERY 10200 W. MARCH POINT ROAD T91WA4428 ANACORTES, WA 98221	CUSTOMER P.O. NO.: 4501667904, CHANGE ORDER #1
PARTS: E6600B HEAT EXCHANGER, PARTS 1B, 4B, AND 5B		DATE: MARCH 8, 2011
PAGE 25 OF 52		

LABORATORY REPORT

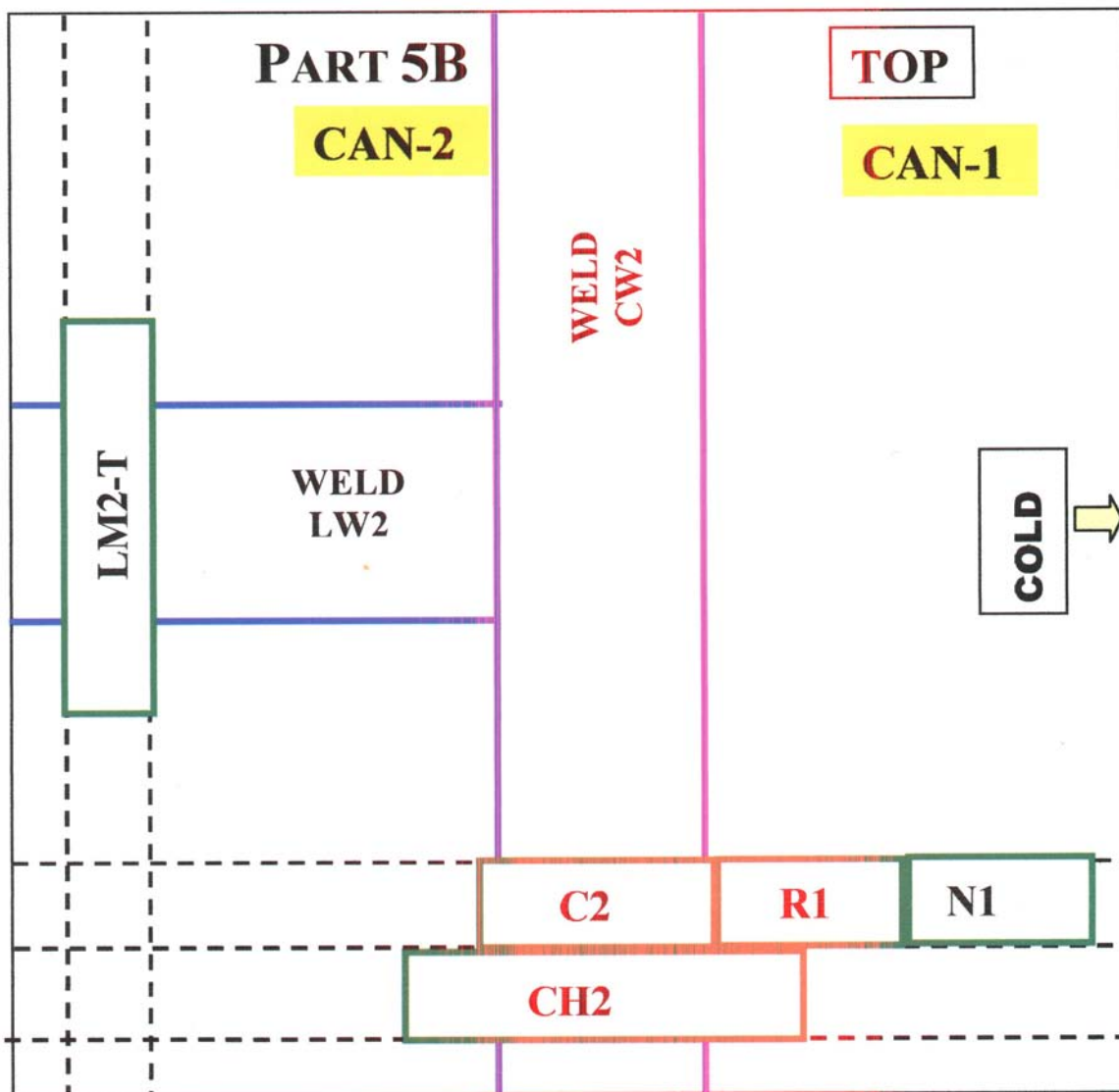
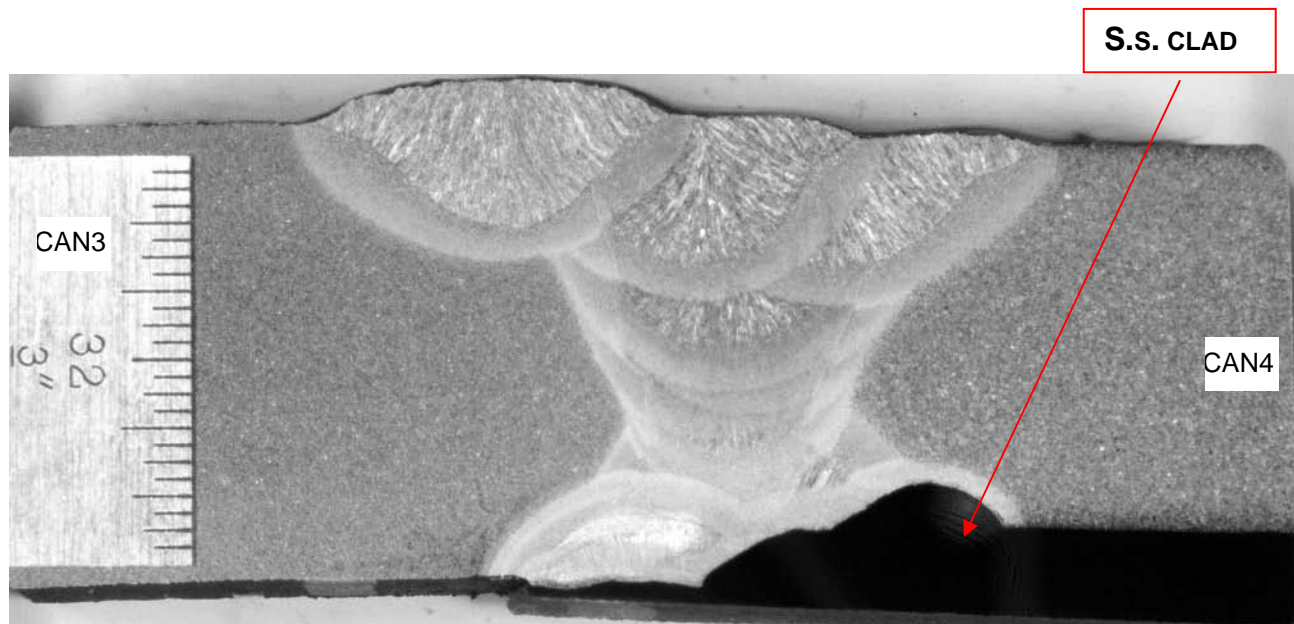

Figure 9b. Sketch of the specimens' layout and labeling. The photograph of the samples labeled and the table with the test to be performed are on Figure 9a above. You are looking at O.D.

BETA LAB NO. M10329-B, TESORO EXCHANGER E6600-B EXAMINATION DATA	TESORO REFINING AND MARKETING COMPANY ANACORTES REFINERY	CUSTOMER P.O. NO.: 4501667904, CHANGE ORDER #1
PARTS: E6600B HEAT EXCHANGER, PARTS 1B, 4B, AND 5B	10200 W. MARCH POINT ROAD T91WA4428 ANACORTES, WA 98221	DATE: MARCH 8, 2011 PAGE 26 OF 52

LABORATORY REPORT



Part 1B. CH4-A mount. Weld CW4



Part 4B. LH2 mount. Weld LW2 located approximately 36" from weld CW3

Figure 10. O.D. is on the top.

BETA LAB NO. M10329-B, TESORO EXCHANGER E6600-B EXAMINATION DATA	TESORO REFINING AND MARKETING COMPANY ANACORTES REFINERY	CUSTOMER P.O. NO.: 4501667904, CHANGE ORDER #1
PARTS: E6600B HEAT EXCHANGER, PARTS 1B, 4B, AND 5B	10200 W. MARCH POINT ROAD T91WA4428 ANACORTES, WA 98221	DATE: MARCH 8, 2011 PAGE 27 OF 52

LABORATORY REPORT



LM2-T mount. Weld LW2 at Tee with weld CW2.



CH2 mount. Weld CW2 at Tee with weld LW2

Figure 11. Macro photographs of two mounts from part 5B located approximately 84" from weld CW3.
O.D. is on the top.

BETA LAB No.M10329-B, TESORO EXCHANGER E6600-B EXAMINATION DATA	TESORO REFINING AND MARKETING COMPANY ANACORTES REFINERY 10200 W. MARCH POINT ROAD T91WA4428 ANACORTES, WA 98221	CUSTOMER P.O. NO.: 4501667904, CHANGE ORDER #1
PARTS: E6600B HEAT EXCHANGER, PARTS 1B, 4B, AND 5B		DATE: MARCH 8, 2011
		PAGE 28 OF 52

LABORATORY REPORT

**MICRO-PHOTOGRAPHS
OF THE AREAS
WITH THE DEEPEST
DAMAGE FOUND**

BETA LAB NO. M10329-B, TESORO EXCHANGER E6600-B EXAMINATION DATA	TESORO REFINING AND MARKETING COMPANY ANACORTES REFINERY 10200 W. MARCH POINT ROAD T91WA4428 ANACORTES, WA 98221	CUSTOMER P.O. NO.: 4501667904, CHANGE ORDER #1
PARTS: E6600B HEAT EXCHANGER, PARTS 1B, 4B, AND 5B		DATE: MARCH 8, 2011
PAGE 29 OF 52		

LABORATORY REPORT
PART 1B, WELD CW4, SAMPLE CH4-A.

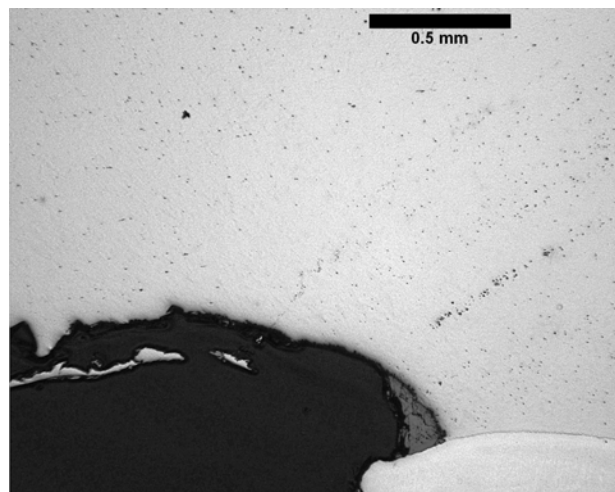

Damage at ID in BM left of weld. Un-etched

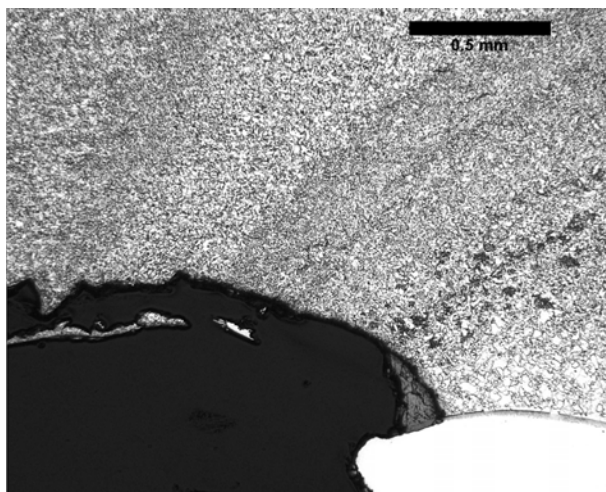

Same as at left. Etched

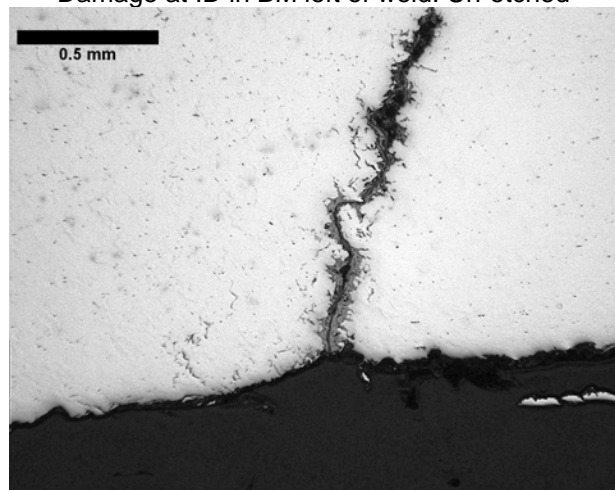

Beginning of the crack left of the weld in BM.
Un-etched

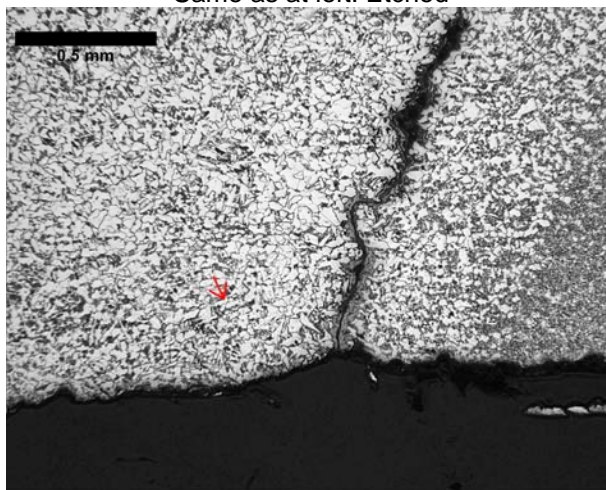

Same as at left. Etched

Figure 12

BETA LAB NO.M10329-B, TESORO EXCHANGER E6600-B EXAMINATION DATA	TESORO REFINING AND MARKETING COMPANY ANACORTES REFINERY 10200 W. MARCH POINT ROAD T91WA4428 ANACORTES, WA 98221	CUSTOMER P.O. No.: 4501667904, CHANGE ORDER #1
PARTS: E6600B HEAT EXCHANGER, PARTS 1B, 4B, AND 5B		DATE: MARCH 8, 2011
PAGE 30 OF 52		

**LABORATORY REPORT
PART 1B, WELD CW4, SAMPLE CH4-A.**

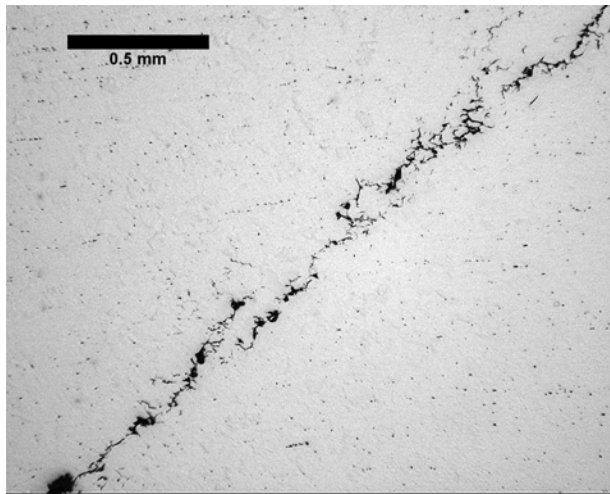

Left of the weld. BM. Middle of the crack.
Un-etched

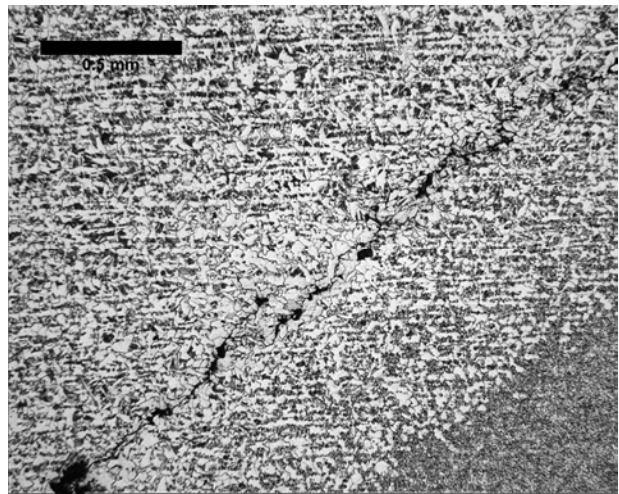

Same as at left. Etched

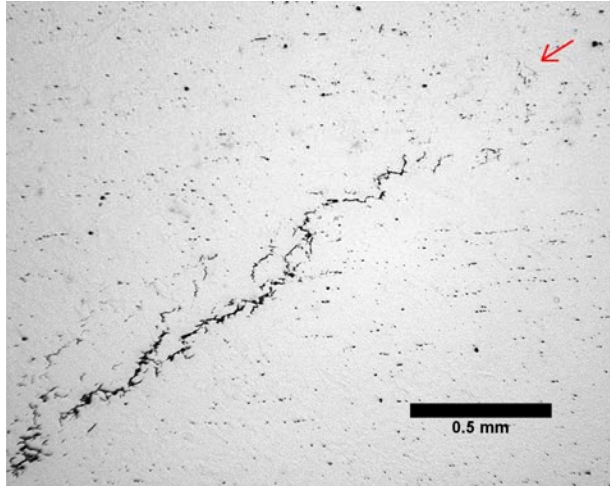

Left of the weld. BM. Tip of the crack.
Un-etched

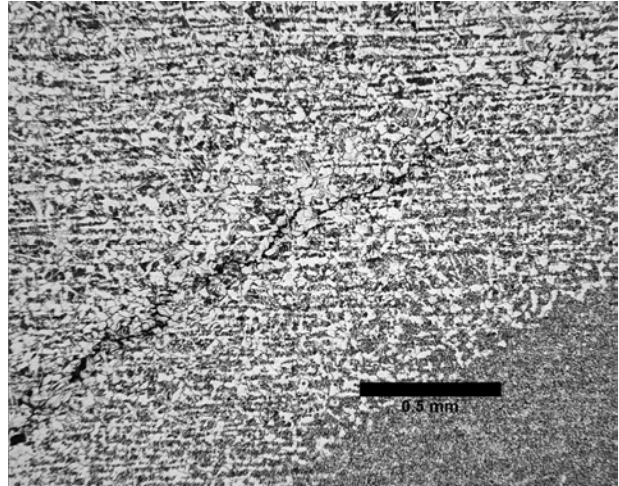

Same as at left. Etched

Figure 13

BETA LAB NO. M10329-B, TESORO EXCHANGER E6600-B EXAMINATION DATA	TESORO REFINING AND MARKETING COMPANY ANACORTES REFINERY 10200 W. MARCH POINT ROAD T91WA4428 ANACORTES, WA 98221	CUSTOMER P.O. NO.: 4501667904, CHANGE ORDER #1
PARTS: E6600B HEAT EXCHANGER, PARTS 1B, 4B, AND 5B		DATE: MARCH 8, 2011
PAGE 31 OF 52		

**LABORATORY REPORT
PART 1B, WELD CW4, SAMPLE CH4-A**

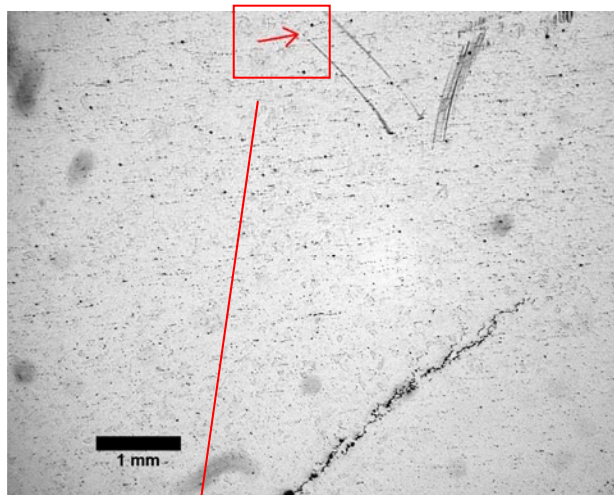

Left of the weld. Deepest damage in BM above the crack tip. Un-etched

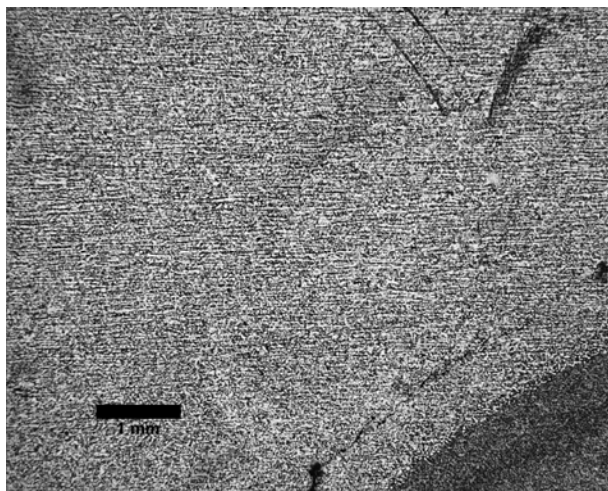

Same as at left. Etched

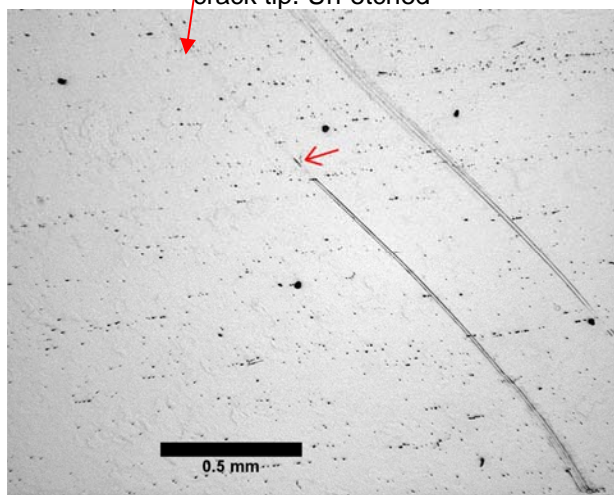

Area from above at higher magnification. Un-etched

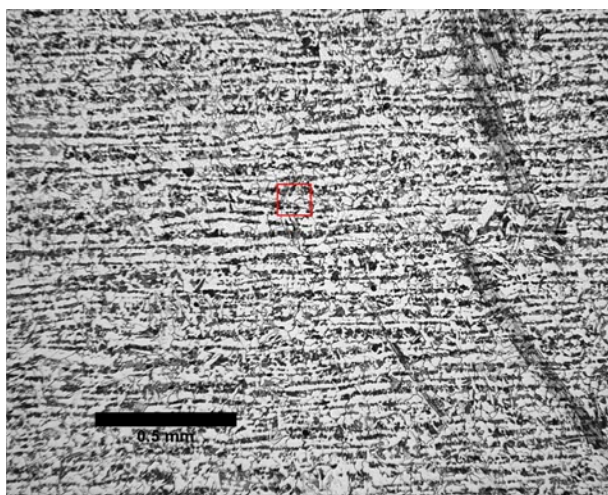

Same as at left. Etched

Damage Depth, mm	
Left of the Weld	Right of the Weld
7.97	0 (Clad)

Figure 14 The lines are the polishing artifacts left untouched for better orientation.

BETA LAB NO. M10329-B, TESORO EXCHANGER E6600-B EXAMINATION DATA	TESORO REFINING AND MARKETING COMPANY ANACORTES REFINERY	CUSTOMER P.O. NO.: 4501667904, CHANGE ORDER #1
PARTS: E6600B HEAT EXCHANGER, PARTS 1B, 4B, AND 5B	10200 W. MARCH POINT ROAD T91WA4428 ANACORTES, WA 98221	DATE: MARCH 8, 2011 PAGE 32 OF 52

LABORATORY REPORT
PART 4B, WELD LW2, SAMPLE LH2.

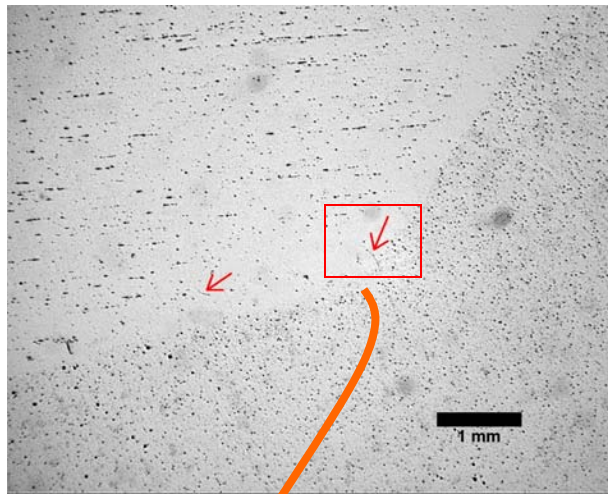

Left of the weld. Un-etched

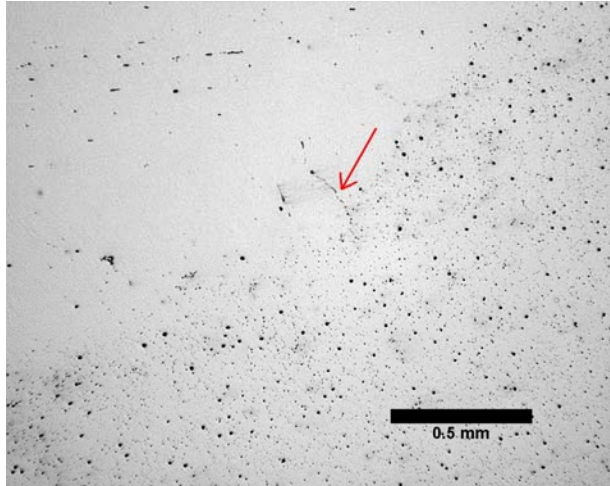

Same as above at higher magnification. Un-etched

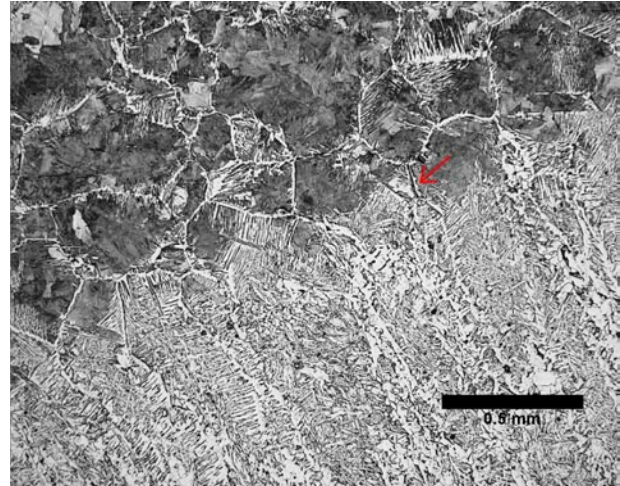

Same as at left. Etched

Damage Depth, mm	
Left of the Weld	Right of the Weld
3.58	3.06

Figure 15.

BETA LAB NO.M10329-B, TESORO EXCHANGER E6600-B EXAMINATION DATA
PARTS: E6600B HEAT EXCHANGER, PARTS 1B, 4B, AND 5B

TESORO REFINING AND MARKETING COMPANY
ANACORTES REFINERY
10200 W. MARCH POINT ROAD T91WA4428
ANACORTES, WA 98221

CUSTOMER P.O. NO.: 4501667904, CHANGE ORDER #1
DATE: MARCH 8, 2011
PAGE 33 OF 52

LABORATORY REPORT
PART 4B, WELD LW2, SAMPLE LH2

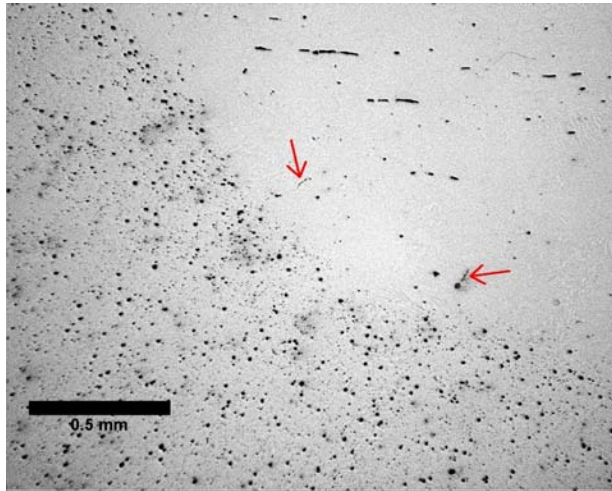

Right of the weld. Un-etched

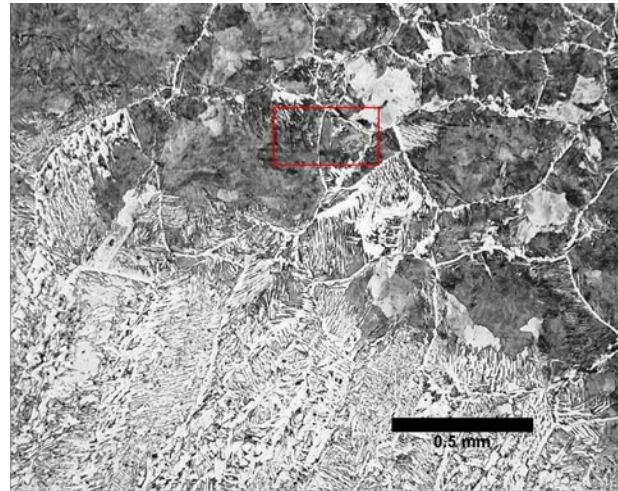

Same as at left. Etched

Damage Depth, mm

Left of the Weld	Right of the Weld
3.58	3.06

Figure 16

BETA LAB NO. M10329-B, TESORO EXCHANGER E6600-B EXAMINATION DATA	TESORO REFINING AND MARKETING COMPANY ANACORTES REFINERY 10200 W. MARCH POINT ROAD T91WA4428 ANACORTES, WA 98221	CUSTOMER P.O. NO.: 4501667904, CHANGE ORDER #1
PARTS: E6600B HEAT EXCHANGER, PARTS 1B, 4B, AND 5B		DATE: MARCH 8, 2011
PAGE 34 OF 52		

LABORATORY REPORT
PART 5B, WELD CW2 AT TEE WITH LW2, SAMPLE CH2.

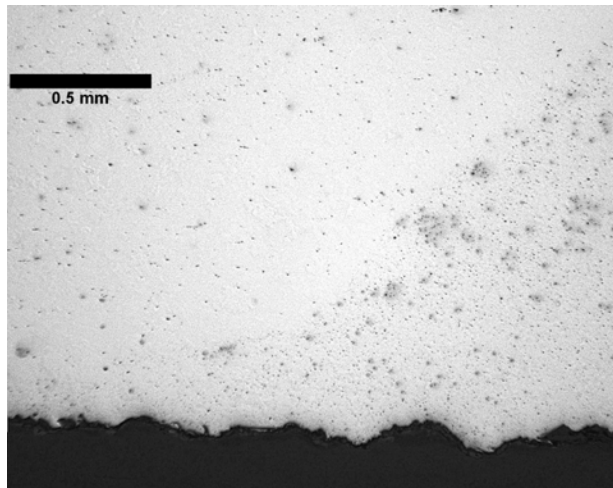

Left of the weld at ID. Un-etched

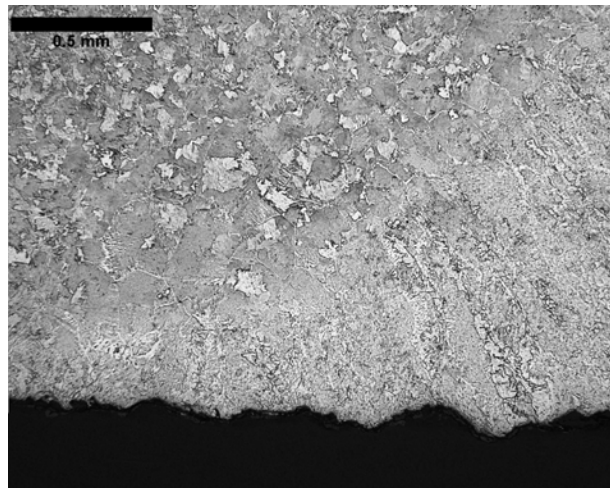

Same as at left. Etched

Damage Depth, mm	
Left of the Weld	Right of the Weld
0	0

Figure 17.

BETA LAB NO.M10329-B, TESORO EXCHANGER E6600-B EXAMINATION DATA	TESORO REFINING AND MARKETING COMPANY ANACORTES REFINERY 10200 W. MARCH POINT ROAD T91WA4428 ANACORTES, WA 98221	CUSTOMER P.O. NO.: 4501667904, CHANGE ORDER #1
PARTS: E6600B HEAT EXCHANGER, PARTS 1B, 4B, AND 5B		DATE: MARCH 8, 2011 PAGE 35 OF 52

LABORATORY REPORT

PART 5B, WELD LW2 AT THE TEE WITH CW2, SAMPLE LM2-T.

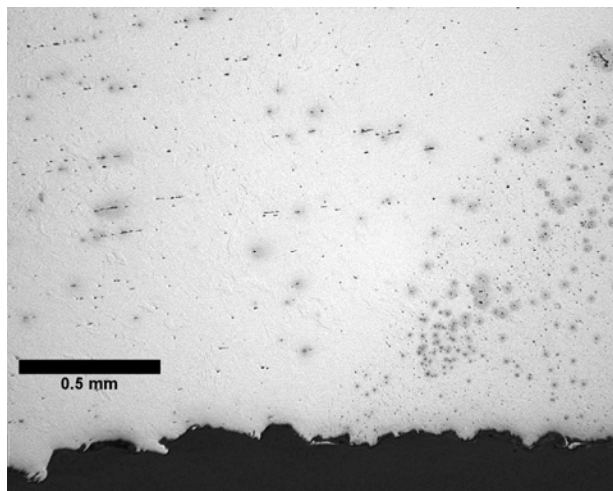

Left of the weld at ID. Un-etched

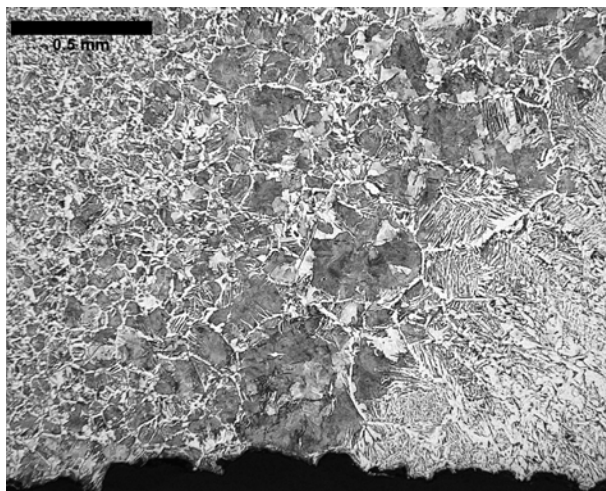

Same as at left. Etched

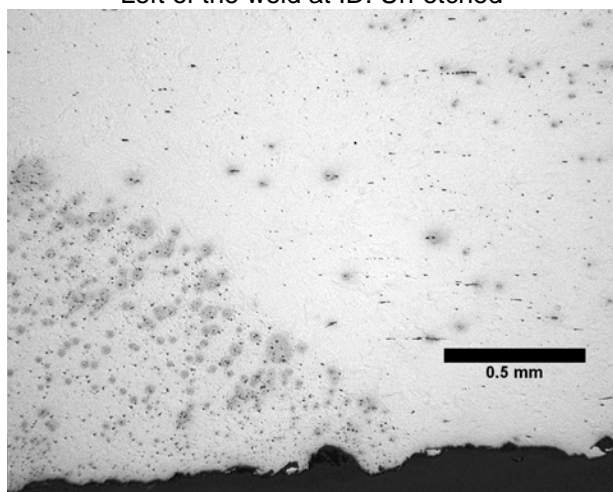

Right of the weld at ID. Un-etched

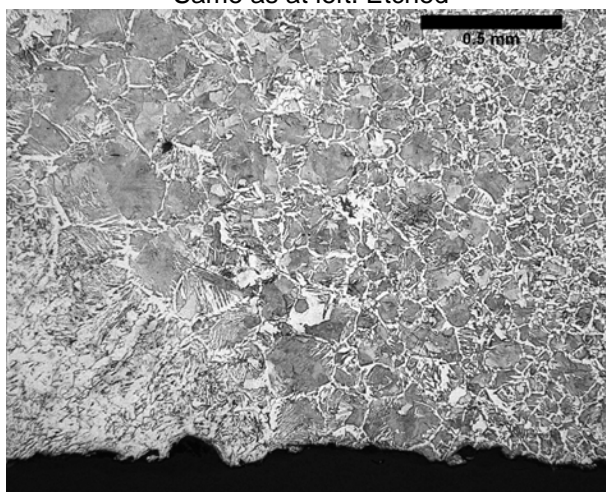

Same as at left. Etched

Damage Depth, mm	
Left of the Weld	Right of the Weld
0	0

Figure 18

BETA LAB NO. M10329-B, TESORO EXCHANGER E6600-B EXAMINATION DATA	TESORO REFINING AND MARKETING COMPANY ANACORTES REFINERY 10200 W. MARCH POINT ROAD T91WA4428 ANACORTES, WA 98221	CUSTOMER P.O. NO.: 4501667904, CHANGE ORDER #1
PARTS: E6600B HEAT EXCHANGER, PARTS 1B, 4B, AND 5B		DATE: MARCH 8, 2011 PAGE 36 OF 52

LABORATORY REPORT

PART 4 B, WELD LW2, SAMPLE LH2. MACRO REVERSED VS TABLE 9 (LEFT AND RIGHT SIDES CHANGED PLACES)

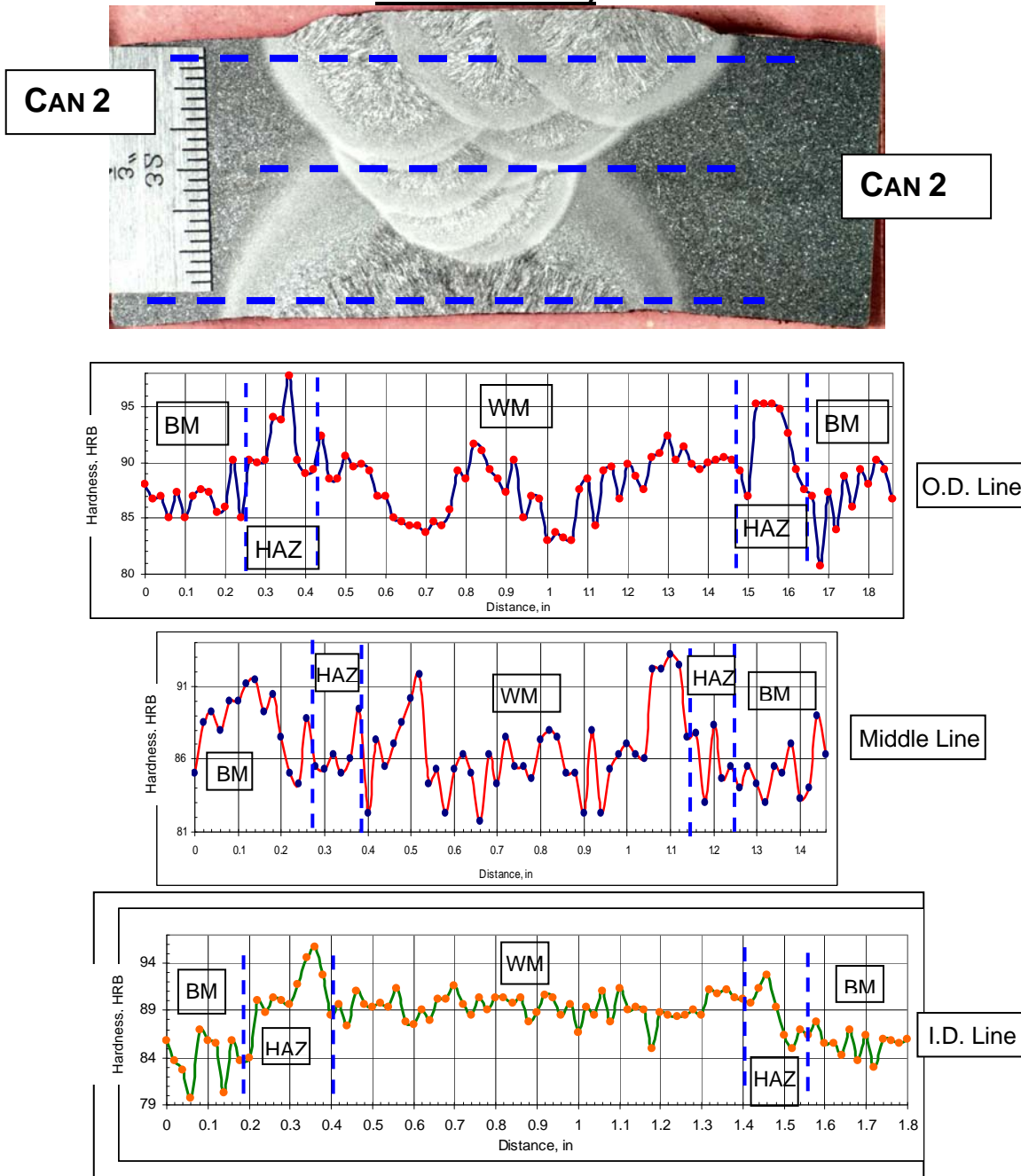

Figure 19. Hardness distribution across LW2 weld at three levels. The macro at the top of the page is flipped to coincide with the hardness data

BETA LAB NO. M10329-B, TESORO EXCHANGER E6600-B EXAMINATION DATA	TESORO REFINING AND MARKETING COMPANY ANACORTES REFINERY 10200 W. MARCH POINT ROAD T91WA4428 ANACORTES, WA 98221	CUSTOMER P.O. NO.: 4501667904, CHANGE ORDER #1
PARTS: E6600B HEAT EXCHANGER, PARTS 1B, 4B, AND 5B		DATE: MARCH 8, 2011
PAGE 37 OF 52		

LABORATORY REPORT

PART 5B, WELD CW2 AT TEE WITH LW2, SAMPLE CH2. MACRO REVERSED VS TABLE 9 (LEFT AND RIGHT SIDES CHANGED PLACES)

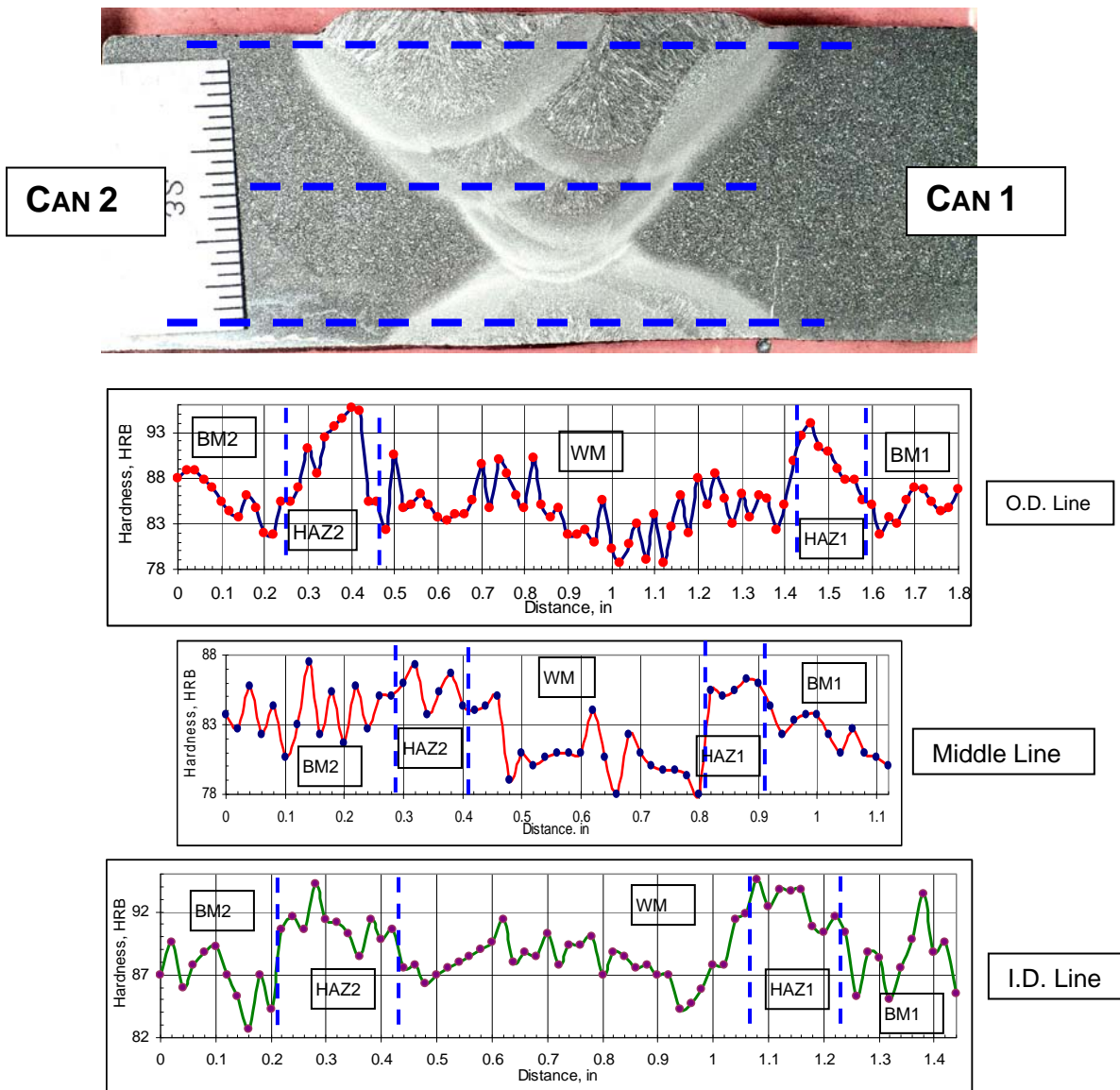

Figure 20. Hardness distribution across CW2 weld at three levels. The macro at the top of the page is flipped to coincide with the hardness data.

BETA LAB NO.M10329-B, TESORO EXCHANGER E6600-B EXAMINATION DATA	TESORO REFINING AND MARKETING COMPANY ANACORTES REFINERY 10200 W. MARCH POINT ROAD T91WA4428 ANACORTES, WA 98221	CUSTOMER P.O. NO.: 4501667904, CHANGE ORDER #1
PARTS: E6600B HEAT EXCHANGER, PARTS 1B, 4B, AND 5B		DATE: MARCH 8, 2011
PAGE 38 OF 52		

LABORATORY REPORT

ATTACHMENT 1 – TEST PROTOCOL AND ADDENDUM

Tesoro Exchanger B Shell Laboratory Examination Protocol

This protocol sets forth specified destructive testing on the shell of Heat Exchanger E6600-B.

Signature parties to this agreement shall receive at least 72 hour notice by the selected laboratory prior to laboratory testing per this protocol with notice by email or by emailed notice of activities in order for signature parties to have the opportunity to be present and observe testing.

1. Material Preparation for Shipment and Receipt

- The E6600-B exchanger shall be submitted to the laboratory as exists in the evidence laydown yard at the Tesoro refinery.
- The exchanger shall be secured to a transport trailer, suitably protected for transport.
- ABS shall create a detailed shipping list and copies of pictures to assist in identification, and generate a chain of custody form signed off by a Tesoro representative.
- ABS shall provide shipping details to the selected laboratory.
- The selected laboratory shall be present at receipt of the exchanger and removal of the exchanger from the transport trailer.
- The selected laboratory shall photograph or have photographed the as received condition of the exchanger and document any shipping damage.
- The exchanger and any collected samples shall be stored in a secure indoor location at a Halvorsen warehouse in the Cleveland OH area. A Halvorsen representative will sign the chain of custody form for the exchanger upon receipt and maintain possession of the original form.

2. Sample Cutting

- Two samples of interest from the B exchanger shell will be removed by air or plasma arc cutting by Halvorsen. One sample is Circ Weld 4 (CW-4) and extends a minimum of six (6) inches on both sides of this weld. The other sample is Longitudinal Weld 3 (LW-3) and also extends a minimum of six (6) inches on both sides of this weld). Locations for welds LW-3 and CW-4 and a description of indications of interest within these welds can be found in CISI Report dated June 24, 2010.
- Cuts will be made on lines marked on the exchanger by Tesoro or their designated representative at locations consistent with previous language above.
- Subsequent to cut line marking and receipt of the exchanger by Halvorsen, notification of intent of cutting shall be made to all signature parties by Halvorsen or the laboratory and cutting shall not commence until three business days have passed since notification to permit review of cut line placement by all signature parties and provide the opportunity to be present to observe the cutting operation.

- 3. A tagging protocol and laboratory chain of custody form shall be developed by the selected laboratory to use for transfer of custody. The laboratory shall use the approved protocol and chain of custody form to take custody of the cut out samples from Halvorsen.**

BETA LAB NO.M10329-B, TESORO EXCHANGER E6600-B EXAMINATION DATA	TESORO REFINING AND MARKETING COMPANY ANACORTES REFINERY 10200 W. MARCH POINT ROAD T91WA4428 ANACORTES, WA 98221	CUSTOMER P.O. NO.: 4501667904, CHANGE ORDER #1
PARTS: E6600B HEAT EXCHANGER, PARTS 1B, 4B, AND 5B		DATE: MARCH 8, 2011
PAGE 39 OF 52		

LABORATORY REPORT

Tesoro Exchanger B Shell Laboratory Examination Protocol

4. *Documentation of Samples – All work to be performed by the selected laboratory*
- Lay out each cut out sample in a separate location.
 - Take initial photographs of “as received” condition of each sample, include tag and reference measurement ruler as appropriate.
 - Examine each sample for specific details in as received condition and document with photographs.

Laboratory NDE Examinations

NDE

1. Take caliper readings or UT readings for thickness at all edges of the samples and document. If there is pitting corrosion damage, use a pit gauge to measure the pit depth of the worst areas of pitting. Take macro hardness readings of each plate in the samples.
2. Inspect the reportedly internally exposed cracked section on CW-4 using dye penetrant (PT). Document the examinations photographically.

Marking and Sample Selection for Analysis

1. Examine each tagged sample for areas where sections will be removed for further detailed analysis. The signature parties or their representatives that are present in the lab shall determine the areas to sample for all analyses. Any and all NDE identified in the previously approved Tesoro Exchanger B Examination Protocol for Field Visual and Nondestructive Examination may be performed as directed by the signature parties or their designated representatives present in the lab to assist in the selection of sections for further laboratory examination.
2. Mark all areas chosen for further examination. Include specimen side to be exposed when mounted.
3. Document those areas chosen with macrophotographs, showing areas to be removed, ID tag, and reference measurements.
4. Mark all remote areas to be taken for general chemical analysis and mechanical tests, including base metal, welds, and Heat Affected Zones (HAZ). The signature parties or their representatives that are present in the lab shall determine areas for analysis and tests.

BETA LAB NO.M10329-B, TESORO EXCHANGER E6600-B EXAMINATION DATA	TESORO REFINING AND MARKETING COMPANY ANACORTES REFINERY 10200 W. MARCH POINT ROAD T91WA4428 ANACORTES, WA 98221	CUSTOMER P.O. NO.: 4501667904, CHANGE ORDER #1
PARTS: E6600B HEAT EXCHANGER, PARTS 1B, 4B, AND 5B		DATE: MARCH 8, 2011
PAGE 40 OF 52		

LABORATORY REPORT

Tesoro Exchanger B Shell Laboratory Examination Protocol

Fractographic/Metallographic Examination

1. Saw selected cutout sections on CW-4 to be mounted or looked at with Macroscope, maintaining tag traceability and side to be examined. Cut back material sufficiently near crack like indications of CW-4 to permit breaking. Cool sections in liquid nitrogen, place in vice and break away material as necessary to exposed crack surfaces on CW-4 selected sections.
2. Examine sections from (1) above with Macroscope and take pictures of all exposed fracture surfaces.
3. Examine un-mounted and unpolished fracture surfaces of interest in an SEM at 5, 50, 100, 500, 1000 and/or 5000X directed by the signature parties or their representatives present in the lab to look for potential initiation sites and clearly describe the fracture surface morphology. Any deposit areas shall be analyzed with EDS analysis as directed by the signature parties or their representatives present in the lab.
4. Cold mount sample pieces from both CW-4 and LW-3 in areas of interest as determined by the signature parties or their representatives present in the lab for metallography using a clear epoxy.
5. Etch control numbers on each mount corresponding to original tags.
6. Grind and polish the surface of each sample using a series of progressively finer grit papers and polishing wheels to obtain a surface suitable for examination under a metallurgical microscope with magnification at 50X, 100X, 200X, 500X, 1000X, and 1500X.
7. Examine each mount in the unetched condition under a Macroscope at 5 to 50X magnification as directed by the signature parties or their representatives present in the lab at the time.
8. Take photomicrographs and document any areas of interest as determined by the signature parties or their representatives present in the lab at the time.
9. Examine each mount under a metallurgical microscope for a higher magnification view of any areas on the sample as directed by the signature parties or the representatives present in the lab at the time.
10. Photograph any areas of interest as determined by the signature parties or their representatives present in the lab at the time.
11. Surface etch each mount with a Nital 2% etch solution (for carbon steel) and reexamine using both the macro and microscopes.

Exchanger B Shell Laboratory Examination Protocol, Rev. 0

7/20/2010

BETA LAB NO.M10329-B, TESORO EXCHANGER E6600-B EXAMINATION DATA	TESORO REFINING AND MARKETING COMPANY ANACORTES REFINERY 10200 W. MARCH POINT ROAD T91WA4428 ANACORTES, WA 98221	CUSTOMER P.O. NO.: 4501667904, CHANGE ORDER #1
PARTS: E6600B HEAT EXCHANGER, PARTS 1B, 4B, AND 5B		DATE: MARCH 8, 2011
PAGE 41 OF 52		

LABORATORY REPORT

Tesoro Exchanger B Shell Laboratory Examination Protocol

12. Photograph and document all areas of interest as directed by the signature parties or their representatives present in the lab at the time.
13. The signature parties or their representatives present in the lab at the time shall decide if any mounts are to be further examined using a Scanning Electron Microscope (SEM) either in the etched or unetched condition in the case of the mounts.
14. Photograph and document all areas of interest as determined by the signature parties or their representatives present in the lab at the time.
15. Perform EDS analysis of any scale or weld/base metal zone on the polished mount samples as directed by the signature parties or their representatives present in the lab at the time.
16. All weld joint cross section specimens shall be given a series of microhardness tests starting in base metal and traveling through the weld HAZ and weld metal at locations determined by the signature parties or their representatives present in the lab at the time.

Mechanical Properties

Testing shall be performed to determine the mechanical properties of the heat exchanger shell at locations determined by the signature parties or their representatives present in the lab at the time. These mechanical tests shall at least include the following:

- Tensile Testing
- Charpy V-notch Impact Testing
- Chemical Analysis

1. Tensile Testing

Tensile test specimens shall be prepared and tested in accordance with ASTM A370 (Mechanical Testing of Steel Products) for the shell base metal and weld seams to measure yield strength, ultimate tensile strength, and elongation. The shell base metal shall, at a minimum be tested in the transverse direction, and weld seam specimens should be taken across the weld seam. Tensile testing in the transverse direction is interpreted as transverse to the original plate rolling direction.

2. Charpy V-notch Impact Testing

Charpy V-notch (CVN) specimens should be prepared and tested in accordance with ASTM E23 (Notched Bar Impact Testing of Metallic Materials) to determine the toughness characteristics of in the transverse direction. Impact testing in the transverse direction is interpreted as transverse to the original plate rolling direction. Transition curves shall be produced with three (3) specimens at each temperature. Results from CVN testing may be reported in some or all of the following forms depending on the testing results:

BETA LAB NO.M10329-B, TESORO EXCHANGER E6600-B EXAMINATION DATA	TESORO REFINING AND MARKETING COMPANY ANACORTES REFINERY 10200 W. MARCH POINT ROAD T91WA4428 ANACORTES, WA 98221	CUSTOMER P.O. NO.: 4501667904, CHANGE ORDER #1
PARTS: E6600B HEAT EXCHANGER, PARTS 1B, 4B, AND 5B		DATE: MARCH 8, 2011
PAGE 42 OF 52		

LABORATORY REPORT

Tesoro Exchanger B Shell Laboratory Examination Protocol

- Upper-Shelf Energy (in ft-lbs)
- Lower-Shelf Energy (in ft-lbs)
- Ductile-to-Brittle Transition Temperature (in °F) determined from graphical representation of testing results
- Fracture Appearance Transition Temperature (in °F) corresponding to 50 % shear
- Lateral expansion (to measure notch toughness)

In some steels it may be difficult to measure percent shear because of “woody” fracture surfaces. In these cases it would be more appropriate to use lateral expansion and absorbed energy measurements to obtain a more accurate transition temperature.

3. Chemical Analysis

Chemistry samples representative of all components at locations as determined by the signature parties or their representatives shall be taken and analyzed per standard lab confirmation compared to ASME Section II material specifications. Perform Leco analysis for carbon content. A determination of carbon equivalent for each test shall be made.

Laboratory Results Reporting/Sample Retention

1. All laboratory tests, including photographs or sketches, should be documented and summarized in a single complete Level 2 lab report which contains descriptive text and captioned photos with the resultant assembly time being a function of the amount of data obtained but is typically 2-3 weeks. No analysis or conclusions shall be provided in the lab report. Any signatory party, its representative, or other party permitted to witness the laboratory testing may have the opportunity to see the data so long as there is no disruption to lab work but no one can have or make any copies of the laboratory work product prior to the Laboratory issuing the test report to the signatory parties.
2. No party shall have the opportunity to review the lab report in advance or the other parties. Any party requesting clarification or correction of anything in the report shall submit their request to the lab and all parties.
3. The Laboratory Report should be signed by a P.E from the laboratory.
4. All samples that are cut, whether used or not and all samples analyzed shall be saved and stored in a manner that minimizes corrosion, by retaining in a container filled with desiccant or wrapping in plastic, etc.
5. The chain of custody form should be signed at all stages where the samples are handled within the lab or removed from the lab for any reason. Any markings/tags should be visible and retained.

BETA LAB NO.M10329-B, TESORO EXCHANGER E6600-B EXAMINATION DATA	TESORO REFINING AND MARKETING COMPANY ANACORTES REFINERY 10200 W. MARCH POINT ROAD T91WA4428 ANACORTES, WA 98221	CUSTOMER P.O. NO.: 4501667904, CHANGE ORDER #1
PARTS: E6600B HEAT EXCHANGER, PARTS 1B, 4B, AND 5B		DATE: MARCH 8, 2011
PAGE 43 OF 52		

LABORATORY REPORT

Tesoro Exchanger B Shell Laboratory Examination Protocol

James Darnell
Vice President, Health and Safety
Tesoro Companies



Signature Date 22 July 2010

Robert Parker
Compliance Manager
Division of Occupational Safety and Health

Signature Date

Robert J. Hall
Investigator-in-Charge
U.S. Chemical Safety Board



Signature Date 27 July 2010

BETA LAB NO.M10329-B, TESORO EXCHANGER E6600-B EXAMINATION DATA	TESORO REFINING AND MARKETING COMPANY ANACORTES REFINERY 10200 W. MARCH POINT ROAD T91WA4428 ANACORTES, WA 98221	CUSTOMER P.O. NO.: 4501667904, CHANGE ORDER #1
PARTS: E6600B HEAT EXCHANGER, PARTS 1B, 4B, AND 5B		DATE: MARCH 8, 2011
PAGE 44 OF 52		

LABORATORY REPORT

Tesoro Exchanger B Shell Laboratory Examination Protocol Addendum – 1: Revisions/Clarifications Sample Cutting

This Addendum 1 to Exchanger B Shell Laboratory Examination Protocol sets forth revisions/clarifications to the Sample Cutting from the Exchanger E6600B and the Fractographic/Metallographic Examination. Except as revised herein, performance of work is to be in accordance with the Exchanger B Shell Laboratory Examination Protocol.

An outline drawing and designation of weld seams of E6600B, and references to the areas of indications discussed in this Addendum, can be found in the June 24, 2010 Spectrum Inspection Report titled: TESORO ANACORTES REFINERY EXCHANGER E6600B.

Areas chosen for metallurgical examination in this sample plan are shown in [Figure 1](#) with cut lines that have been marked on the exchanger by Tesoro or its designated representative. Chosen locations are the longitudinal weld seam LW3 ([Figure 2](#)), circumferential weld seam CW4 ([Figure 3](#)), and the weld seam "T" junction of LW3/CW3 ([Figure 4](#)). Two of those areas ([Figures 2 and 3](#)) are listed as containing weld zone indications in the Spectrum Inspection Report dated June 24, 2010, and one area that was chosen, [Figure 4](#), was free of any reported indications. The following detailed sample plan replaces the first two bullet points under item 2 of the Exchanger B Shell Laboratory Examination Protocol:

Detailed Sample Plan

Longitudinal Seam LW3

- Mark out an area on long seam LW3 approximately 6" along the seam and 6" wide.
- Center this sample location on the designated 10" continuous mid wall lack of fusion (LOF) indication listed in the Spectrum report and marked on the surface of the E6600B exchanger shell.
- Photograph the marked area prior to cutting out the sample plate.
- Cut the sample using the plasma arc or oxyacetylene process.
- Cut samples for weld metal and base metal chemistry.
- Cut one sample for a weld cross section metallurgical mount in the 10" LOF zone.
- Perform a weld and base metal hardness traverse across the cross section mount.
- Cut one sample in the 10" LOF zone for fractography.

Circumferential Seam CW4

- Mark out an area on circumferential seam CW4 approximately 12" long by 12" wide.
- Locate this area on the designated lack of fusion (LOF) zone.
- Photograph the marked area prior to cutting out the plate.
- Cut the sample using the plasma arc or oxyacetylene process.
- Cut samples for weld metal and base metal chemistry.
- Cut samples for two cross weld tensile tests, tests to be machined reduced size samples to provide areas of sound weld.
- Cut one sample for a weld cross section metallurgical mount.
- Perform a weld and base metal hardness traverse across the cross section mount.
- Cut one sample in the LOF zone for fractography.

Page 1 of 5

Addendum 1 Exchanger B Laboratory Protocol

BETA LAB NO.M10329-B, TESORO EXCHANGER E6600-B EXAMINATION DATA	TESORO REFINING AND MARKETING COMPANY ANACORTES REFINERY 10200 W. MARCH POINT ROAD T91WA4428 ANACORTES, WA 98221	CUSTOMER P.O. NO.: 4501667904, CHANGE ORDER #1
PARTS: E6600B HEAT EXCHANGER, PARTS 1B, 4B, AND 5B		DATE: MARCH 8, 2011
PAGE 45 OF 52		

LABORATORY REPORT

Tesoro Exchanger B Shell Laboratory Examination Protocol
 Addendum – 1: Revisions/Clarifications Sample Cutting

"T" Joint between Circumferential Seam CW3 and Longitudinal Seam LW3

- Mark out an area on the "T" joint of the circumferential seam CW3 and the longitudinal seam LW3 approximately 6" long by 6" wide.
- Center this area on the "T" joint intersection.
- Photograph the marked area prior to cutting out the plate.
- Cut the sample using the plasma arc or oxyacetylene process.
- Cut a sample for weld metal chemistry of CW3.
- Cut one sample for a weld cross section metallurgical mount of LW3 and one sample for a mount of CW3.
- Perform a weld and base metal hardness traverse across both cross section mounts.

James Darnell
 Vice President, Health and Safety
 Tesoro Companies, Inc.



 Signature 16 SEPT. 2010
Date

Robert Parker
 Compliance Manager
 Division of Occupational Safety and Health



 Signature 9-16-10
Date

Robert J. Hall
 Investigator-In-Charge
 U.S. Chemical Safety Board



 Signature 9-23-10
Date

BETA LAB NO.M10329-B, TESORO EXCHANGER E6600-B EXAMINATION DATA	TESORO REFINING AND MARKETING COMPANY ANACORTES REFINERY 10200 W. MARCH POINT ROAD T91WA4428 ANACORTES, WA 98221	CUSTOMER P.O. NO.: 4501667904, CHANGE ORDER #1
PARTS: E6600B HEAT EXCHANGER, PARTS 1B, 4B, AND 5B		DATE: MARCH 8, 2011
PAGE 46 OF 52		

LABORATORY REPORT

Tesoro Exchanger B Shell Laboratory Examination Protocol
Addendum – 1: Revisions/Clarifications Sample Cutting

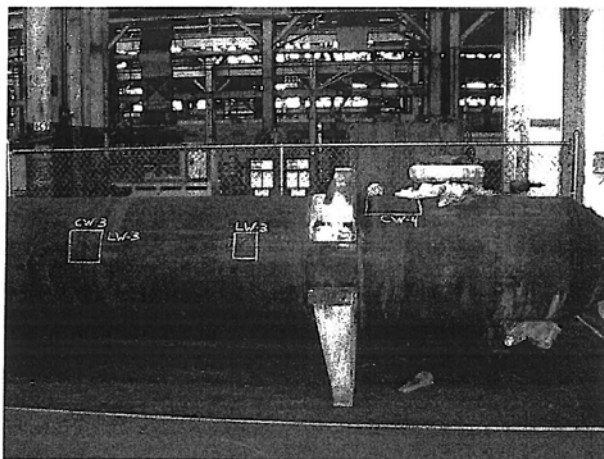

Figure 1: Overview of all three sample locations

BETA LAB No.M10329-B, TESORO EXCHANGER E6600-B EXAMINATION DATA	TESORO REFINING AND MARKETING COMPANY ANACORTES REFINERY 10200 W. MARCH POINT ROAD T91WA4428 ANACORTES, WA 98221	CUSTOMER P.O. No.: 4501667904, CHANGE ORDER #1
PARTS: E6600B HEAT EXCHANGER, PARTS 1B, 4B, AND 5B		DATE: MARCH 8, 2011
PAGE 47 OF 52		

LABORATORY REPORT

Tesoro Exchanger B Shell Laboratory Examination Protocol
Addendum – 1: Revisions/Clarifications Sample Cutting

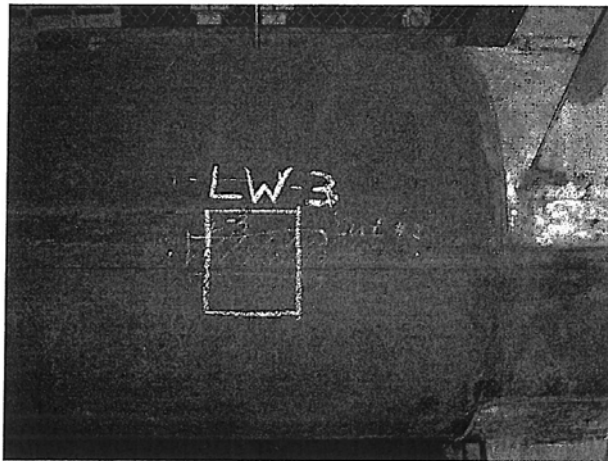

Figure 2: Long Seam Sample, LW-3

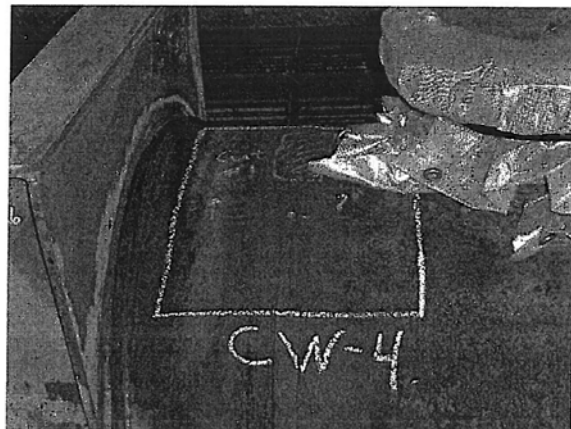

Figure 3: Girth Weld Sample, CW-4

BETA LAB NO.M10329-B, TESORO EXCHANGER E6600-B EXAMINATION DATA	TESORO REFINING AND MARKETING COMPANY ANACORTES REFINERY 10200 W. MARCH POINT ROAD T91WA4428 ANACORTES, WA 98221	CUSTOMER P.O. NO.: 4501667904, CHANGE ORDER #1
PARTS: E6600B HEAT EXCHANGER, PARTS 1B, 4B, AND 5B		DATE: MARCH 8, 2011
PAGE 48 OF 52		

LABORATORY REPORT

Tesoro Exchanger B Shell Laboratory Examination Protocol
 Addendum – 1: Revisions/Clarifications Sample Cutting

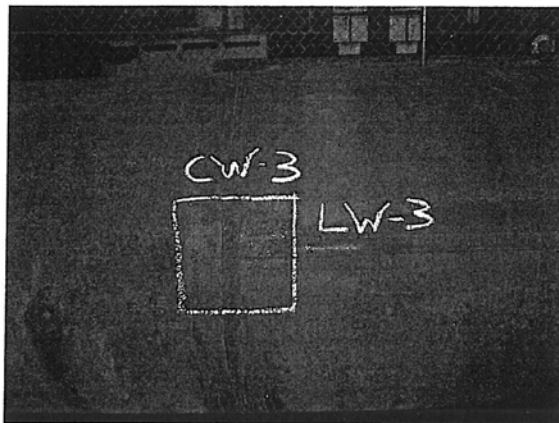

Figure 4: "T" Joint Weld Junction, CW-3/LW-3

BETA LAB NO. M10329-B, TESORO EXCHANGER E6600-B EXAMINATION DATA	TESORO REFINING AND MARKETING COMPANY ANACORTES REFINERY 10200 W. MARCH POINT ROAD T91WA4428 ANACORTES, WA 98221	CUSTOMER P.O. NO.: 4501667904, CHANGE ORDER #1
PARTS: E6600B HEAT EXCHANGER, PARTS 1B, 4B, AND 5B		DATE: MARCH 8, 2011
PAGE 49 OF 52		

LABORATORY REPORT

ATTACHMENT 2 – EXCHANGER E6600B ADDITIONAL TESTS PROTOCOL (DESCRIBED AND APPROVED IN 3 E-MAILS BELOW)

RE: M10198 E-6600E Heat Exchanger M10329 B- 6600E Heat Exchanger Tesoro PO 4501667904 and change order 1 Project Schedule
 McVay, Jim to: jblough@firstenergycorp.com 01/14/2011 02:01 AM
 From: "McVay, Jim" <James.W.McVay@tsocorp.com>
 To: "jblough@firstenergycorp.com" <jblough@firstenergycorp.com>
 Cc: "rryoung@equityeng.com" <rryoung@equityeng.com>, "gmbuchheim@equityeng.com" <gmbuchheim@equityeng.com>, "mbridavsky@firstenergycorp.com" <mbridavsky@firstenergycorp.com>

All the sampling and work discussed below is a "go" so I would like Bob to mark up and take pics of the sample locations on the long seam weld so I can make a submittal late next week to the agencies.

From: jblough@firstenergycorp.com [jblough@firstenergycorp.com]
Sent: Thursday, January 13, 2011 11:05 AM
To: McVay, Jim
Cc: rryoung@equityeng.com; gmbuchheim@equityeng.com; mbridavsky@firstenergycorp.com
Subject: M10198 E-6600E Heat Exchanger M10329 B- 6600E Heat Exchanger Tesoro PO 4501667904 and change order 1 Project Schedule

Jim,
 The following are the scheduled dates for the remaining testing and report deliverables. In all cases we will attempt to improve the schedule where possible.

"E"

- 1 Data availability for the depth table on all mounts -January 28, 2011
2. Report including depth table, photos at maximum depth and summary tables of chemistry, hardness, etc- February 25, 2011

"B"

1. Report of additional mount on CW4 - March 18, 2011
2. Report on two additional samples (LW2 36" and 84") - March 25, 2011 provided the approval for this work scope is obtained and samples are cut and delivered to BETA by February 4, 2011

Thanks

Jeff

BETA LAB NO.M10329-B, TESORO EXCHANGER E6600-B EXAMINATION DATA	TESORO REFINING AND MARKETING COMPANY ANACORTES REFINERY 10200 W. MARCH POINT ROAD T91WA4428 ANACORTES, WA 98221	CUSTOMER P.O. NO.: 4501667904, CHANGE ORDER #1
PARTS: E6600B HEAT EXCHANGER, PARTS 1B, 4B, AND 5B		DATE: MARCH 8, 2011
PAGE 50 OF 52		

LABORATORY REPORT**ATTACHMENT 2 (CONTINUED)**

From: Robert Young <rryoung@equityeng.com>
To: "James.W.McVay@tsocorp.com" <James.W.McVay@tsocorp.com>
Cc: "James C. Sowinski" <jcsowinski@equityeng.com>, "Gerrit M. Buchheim" <gmbuchheim@equityeng.com>, "jblough@firstenergycorp.com" <jblough@firstenergycorp.com>
Date: 01/20/2011 10:51 AM
Subject: RE: NHT Incident Investigation: ATTORNEY CLIENT PRIVILEGED/ATTORNEY WORK PRODUCT: E6600-B Exchanger Samples

"B" Exchanger Additional Sample Locations for the E6600-B NHT Exchanger

Jim, please find attached three photos showing the locations of the additional B exchanger weld samples as previously discussed.

LW2-36 is a 6" square located 36" from the CW3 girth weld seam in the direction towards the cold end of the exchanger and located on the LW2 long seam.

W2-84 is a 6" square located 84" from the CW3 girth weld seam in the direction towards the cold end of the exchanger and located on the "T" juncture of the LW2 long seam and the CW2 girth seam.

Please give me a call if you have any comments.
Bob

Robert R. Young
Principal Engineer

The Equity Engineering Group, Inc.
20600 Chagrin Blvd. Suite 1200
Shaker Heights, OH 44122
Office: 1-216-658-4756
Cell: 1-216-659-5701
Fax: 1-216-283-6022

Smart Technology for Aging Infrastructure
www.equityeng.com

BETA LAB NO.M10329-B, TESORO EXCHANGER E6600-B EXAMINATION DATA	TESORO REFINING AND MARKETING COMPANY ANACORTES REFINERY 10200 W. MARCH POINT ROAD T91WA4428 ANACORTES, WA 98221	CUSTOMER P.O. NO.: 4501667904, CHANGE ORDER #1
PARTS: E6600B HEAT EXCHANGER, PARTS 1B, 4B, AND 5B		DATE: MARCH 8, 2011
PAGE 51 OF 52		

LABORATORY REPORT
ATTACHMENT 2 (CONTINUED)

From: Manuel, Don [mailto:Don.J.Manuel@tsocorp.com]
Sent: Thursday, February 03, 2011 04:26 PM
To: 'Hall, Rob' <Rob.Hall@csb.gov>; Parker, Robert T (LNI)
Cc: Bannick, Christian M (LNI); Magee, Charles L. <Charles.L.Magee@tsocorp.com>; McVay, Jim <James.W.McVay@tsocorp.com>
Subject: Additional Sampling on the E-6600B Exchanger Shell

Robert/Bob,

Tesoro requests agreement from all signature parties to additional sampling on the LW-2 long seam weld on the shell of E6600B:

- a. **LW2-36** is a 6" square located 36" from the CW3 girth weld seam in the direction towards the cold end of the exchanger and located on the LW2 long seam.
- b. **LW2-84** is a 6" square located 84" from the CW3 girth weld seam in the direction towards the cold end of the exchanger and located on the "T" juncture of the LW2 long seam and the CW2 girth seam.

The E6600B exchanger shell has been marked in the field in the intended locations and pictures are provided as attachments.

Laboratory testing on these samples would be performed in accordance with the existing approved testing protocol for the E6600B shell. The laboratory would be directed to make one metallurgical mount of the LW-2 weld from each sample. The mounts would be prepared and examined by use of the microscope and/or SEM in accordance with the approved protocol at the direction of experts from the signature parties present for the examinations. At a minimum experts from Equity Engineering will be present to direct laboratory examination.

The lab schedule for preparation and testing in accordance with the above revised sampling and testing plan is as follows:

- a. Remove samples week of February 7, 2011.
- b. Laboratory preparation and testing will begin February 21, 2011 and should conclude March 4, 2011.
- c. A final report on work should be issued by March 25, 2011.

Thanks,
 Don

BETA LAB NO. M10329-B, TESORO EXCHANGER E6600-B EXAMINATION DATA	TESORO REFINING AND MARKETING COMPANY ANACORTES REFINERY 10200 W. MARCH POINT ROAD T91WA4428 ANACORTES, WA 98221	CUSTOMER P.O. NO.: 4501667904, CHANGE ORDER #1
PARTS: E6600B HEAT EXCHANGER, PARTS 1B, 4B, AND 5B		DATE: MARCH 8, 2011
		PAGE 52 OF 52

LABORATORY REPORT

Attachment 3

TEST EQUIPMENT and PROCEDURES

TEST	INSTRUMENT & MODEL	CALIBRATION DUE DATE	BETA No.	LSS PROCEDURE	
				NUMBER & TITLE	REV No.
Failure Analysis	N/A	N/A	N/A	B0069 Failure Analysis	0
Chemical Analysis	Thermo ARL 3460 Optical Emission Spectrometer	Performance check prior to use	BETA 665	B0068 ARL 3460 Optical Emission Spectrometer Analysis	2
SEM/EDS	Amray Scanning Electron Microscope, Model: 1830T4, S/N: 18321002, with IXRF Energy Dispersive X-ray Spectrometer	*	BETA 386 BETA 755	B0064	*
SEM/EDS	Camscan Scanning Electron Microscope, Model: MV2300U, S/N: US0187039/VG0540181U with IXRF Energy Dispersive X-ray Spectrometer and x-ray Optics/AAT Detector	March 14, 2011	BETA 602 BETA 756	B0047 CAMSCAN/IXRF SEM/EDS System	*
Rockwell Hardness	Wilson Rockwell 524T Hardness Tester, Model 83259910	Performance check prior to use	BETA 400	D0027 Wilson Rockwell Model 524T Hardness Tester	5
Rockwell Hardness	NewAge NI300-C Hardness Tester, Model 8150 S/N 951480	Performance check prior to use	BETA 897	D0052	*
Knoop/Vickers Hardness	Buehler Micromet II Digital Microhardness Tester, Model B-D58222	Performance check prior to use	BETA 401	D0028	*
Knoop/Vickers Hardness by Image Analysis	Buehler Micromet II Digital Microhardness Tester, Model B-D58222 with Buehler OmniMet Analysis System Program Version 9.0 Rev 3	Performance check prior to use	BETA 401 BETA 977	D0028	*
Field Hardness	Proceq Equotip Hardness Tester, Model 25-819	Performance check prior to use	BETA 428	D0016	*
Knoop/Vickers, Semi-Micro Vickers Hardness	Instron Tukon 2100B Hardness Tester, Model T2100BR1942	Performance check prior to use	BETA 2006	D0068 Instron Tukon 2100B Hardness Tester	0
Reagent Preparation [^]	N/A	N/A	N/A	C0005 Metallurgical Reagents ▲	7
Linear Measurements by Optical Methods	LECO PMG-3 Inverted Metallograph with Buehler OmniMet Analysis System Program Version 9.0 Rev 3	6/1/2011	BETA 419 BETA 977	D0065	0
Average Grain Size	LECO PMG-3 Inverted Metallograph with Buehler OmniMet Analysis System Program Version 9.0 Rev 3	*	BETA 419 BETA 977	D0066	*
Dimensional	Starrett Micrometer Number 222	9/29/2011	BETA DLC-C-094	NA	NA
Dimensional	Starrett Vernier S/N 120 A	*	BETA 2005	NA	NA
Dimensional	Mitutoyo Digital Micrometer 342-361	*	BETA 884	NA	NA
Mass	Mettler AE-100 S/N C-31383	*	BETA 113	NA	NA
Carbon Analysis	Leco Carbon/Sulfur Determinator CS-444	Performance check prior to use	BETA 1061 BETA 1062	CST-19	0

*Denotes procedures or instruments not used in this report

▲ Etchant 5-1, 2% Nital